

**Gamma completa veicoli**  
***Complete range of vehicles***  
**Gamme complète de véhicules**  
***Komplettes Produktprogramm Fahrzeuge***  
**Gama completa vehiculos**

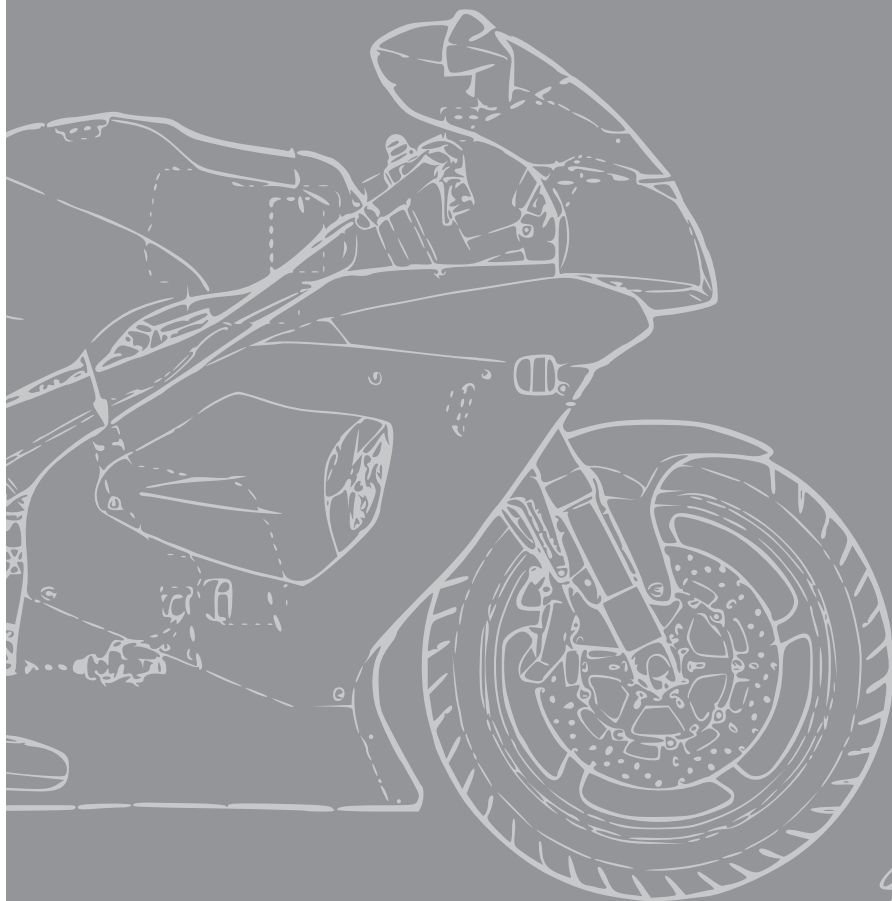

1



Genuine

Serie Oro

Genuine

Serie Oro

**ADIVA**

250	ADIVA	06>	•		68B407B6		68B40776
-----	-------	-----	---	--	----------	--	----------

**AGRATI GARELLI**

50	BIG WHEEL	93>	•		68B40710		68B40710
50	BIP-RACING	94>	•		68B40710		
50	GRINTA	95	•		68B40710		
50	PONY SR	95	•		68B40710		
50	QUEENIE	95>	•		68B40710		

**APRILIA**

50	AMICO-F- X-SPORT	92>94	•		68B40710		
50	AREA 51	98>00	•			108489930	68B40717
50	AREA 51 SUPERBIKE	00>01	•			108489930	68B40717
50	CAPIROSSI	98	•	108489930	68B40717	108489930	68B40717
50	GULLIVER	95>00	•	108489930	68B40717		
50	HABANA	99>	•	108489930	68B40717		
50	HABANA CUSTOM	99>	•	108489930	68B40717		
50	MCGULLIVER	95>	•	108489930	68B40717		
50	MOJITO	04>08	•	108489930	68B40717		
50	MOJITO CUSTOM	99>03	•	108489930	68B40717		
50	MOJITO RETRO	99>03	•	108489930	68B40717		
50	RALLY	92>96	•	108489930	68B40717		
50	RALLY	97>	•	108489930	68B40717	108489930	68B40717
50	RALLY AC	96>	•	108489930	68B40717		
50	RALLY LC	92>96	•	108489930	68B40717		
50	RALLY LC	97>	•	108489930	68B40717	108489930	68B40717
50	RS	99>05	•			108489923	
50	SCARABEO	94>97	•		68B40736		
50	SCARABEO	98>05	•		68B40733	108489930	68B40717
50	SCARABEO 4T	02>06	•		68B40733		
50	SCARABEO 4T RESTYLING	06>08	•		68B40733		
50	SCARABEO BRIGHT/DE LUXE	98>	•		68B40733	108489930	68B40717
50	SCARABEO DITECH	02>04	•		68B40733	108489930	68B40717
50	SCARABEO STREET	98>08	•		68B40733		
50	SONIC GP/SPICE	98>08	•		68B40710		
50	SPORTCITY ONE 2T/4T	09>	•		68B40730		
50	SPORTCITY ONE STREET	09>	•		68B40730		
50	SR DITECH	00>03	•	108489930	68B40717	108489930	68B40717
50	SR EUROPA	93>	•	108489930	68B40717		
50	SR LC	94>96	•	108489930	68B40717		68B40719
50	SR R	05>	•	108489930	68B40717	108489930	68B40717
50	SR R FACTORY	03>04	•	108489930	68B40717		68B40719
50	SR R FACTORY	05>08	•		68B40719	108489930	68B40717
50	SR R/R FACTORY	09>	•	108489930	68B40717	108489930	68B40717
50	SR R/R FACTORY REPLICA SBK	10>	•	108489930	68B40717	108489930	68B40717
50	SR RACING/STEALTH LC	97>99	•	108489930	68B40717	108489930	68B40717
50	SR STREET	03>08	•		68B40719	108489930	68B40717
50	SR URBAN KID	93>	•	108489930	68B40717		
50	SR VIPER-REPLICA	94>	•	108489930	68B40717		
50	SR WWW. NETSCAPER	97>01	•	108489930	68B40717		
50	TUONO	03>04	•			108489923	
50	VIPER-REPLICA	94>	•	108489930	68B40717		
70	SCARABEO	94>98	•		68B40736		
100	SCARABEO	99>	•		68B40733		
125	AF1 FUTURA	90>92	•		<b>78B40870</b>		
125	ATLANTIC	03>	•		68B40773		68B40719
125	EXTREMA	97>	•	108489982	<b>78B40870</b>		68B40753
125	HABANA	99>	•	108489930	68B40717		
125	HABANA CUSTOM	00>	•	108489930	68B40717		
125	HABANA DITECH	02>	•	108489930	68B40717		
125	LEONARDO	95>98	•		68B40732	108489930	68B40717
125	LEONARDO	99>	•		68B40732		68B40717
125	LEONARDO ST	03>	•		68B40733		68B40717
125	MOJITO	03>08	•	108489930	68B40717		
125	MOJITO CUSTOM	99>01	•	108489930	68B40717		
125	MOJITO RETRO	99>01	•	108489930	68B40717		
125	MX	04>07	•	108489983	<b>78B40870</b>		68B40753
125	PEGASO	89>94	•				68B40753
125	RS	96>	•	108489983	<b>78B40870</b>	108489923	



Genuine

Serie Oro

Genuine

Serie Oro

**APRILIA**

125	RS EXTREMA	89>91	•	108489982	<b>78B40870</b>		68B40753
125	RS EXTREMA	92>97	•		<b>78B40870</b>		68B40753
125	RS REPLICA	92>97	•		<b>78B40870</b>		68B40753
125	SCARABEO	98	•		68B40736		
125	SCARABEO	99>03	•		68B407B0		68B40732
125	SCARABEO	04>07	•		68B407B0		68B40773
125	SCARABEO GT	03>	•		68B407B0		68B40733
125	SCARABEO I.E.	08>	•		68B407B0	108489923	
125	SPORTCITY	05>	•		68B407B0		
125	SPORTCITY	06>	•		68B407B0		68B40732
125	SPORTCITY CUBE	09>	•		68B407B0		68B40732
125	SPORT PRODUCTION	92	•	108489982	<b>78B40870</b>		
125	SR	99>	•	108489930	68B40717	108489930	68B40717
125	SR REPLICA	99>01	•	108489930	68B40717	108489930	68B40717
125	TUAREG RALLY	89>92	•				68B40753
125	TUONO	04>05	•	108489983	<b>78B40870</b>	108489923	
150	LEONARDO	96>98	•		68B40732	108489930	68B40717
150	LEONARDO	99>	•		68B40732		68B40732
150	MOJITO	03>07	•	108489930	68B40717		
150	SCARABEO	98	•		68B40736		
150	SCARABEO	99>02	•		68B407B0		68B40732
150	SR	99>01	•	108489930	68B40717	108489930	68B40717
150	SR REPLICA	99>	•	108489930	68B40717	108489930	68B40717
200	ATLANTIC	03>	•		68B40773		68B40719
200	SCARABEO GT	01>06	•		68B407B0		68B40732
200	SCARABEO LIGHT/I.E.	07>	•		68B407B0	108489923	
200	SPORTCITY	04>	•		68B407B0		68B40732
200	SPORTCITY CUBE	09>	•		68B407B0		68B40732
250	ATLANTIC	04>	•		68B40773		68B40719
250	LEONARDO	99>04	•		68B40732		68B40736
250	RS	94>	••	108489975		108489923	
250	SCARABEO	04>05	•		68B407B0		68B40777
250	SCARABEO I.E.	06>	•		68B407B0		68B40777
250	SPORTCITY	06>08	••		68B407B0		68B40732
300	ATLANTIC	10>	•		68B40773		68B40719
300	LEONARDO ST	05>	••		68B40732		68B40736
300	SCARABEO SPECIAL/I.E.	09>	•		68B407B0		68B40777
300	SPORTCITY CUBE	08>	••		68B407B0		68B40732
400	ATLANTIC SPRINT	06>	••		68B407B0		68B40719
400	SCARABEO I.E.	06>	••		68B407B0		68B40777
400	SCARABEO LIGHT	07>	••		68B407B0	108489923	
500	ATLANTIC	01>05	••		68B407B0		68B40736
500	ATLANTIC SPRINT	05	•		68B407B0		68B40719
500	ATLANTIC SPRINT	06>	•		68B407B0		68B40736
500	SCARABEO	04>05	••		68B407B0		68B40736
500	SCARABEO CLASS	10>	••		68B407B0		68B40777
500	SCARABEO I.E./GT ABS	06>	••		68B407B0		68B40777
500	SCARABEO LIGHT	07>	••		68B407B0	108489923	
600	PEGASO	89>91	•				68B40753
650	CUBE	93>00	•	208489955			68B40753
650	CUBE	01>	•	208489955			68B40781
650	PEGASO	91>92	•	208489955			68B40753
650	PEGASO	93>00	•	208489955			68B40753
650	PEGASO I.E.	01>04	•	208489955			68B40781
650	PEGASO STRADA	05>09	•	108200370	<b>78B40870</b>		68B40781
650	PEGASO TRAIL	05>08	•	208489955			68B40781
750	DORSODURO	08>	••		<b>78B40870</b>		
750	DORSODURO FACTORY	10>	••		<b>78B40870</b>		
750	SL SHIVER	07>	••		<b>78B40870</b>		
750	SHIVER GT ABS	09>	••		<b>78B40870</b>		
850	MANA	07>09	••		<b>78B40870</b>		
850	MANA GT	09>	••		<b>78B40870</b>		
1000	ETV CAPONORD	01>	••			108489946	
1000	ETV CAPONORD ABS	04>	••			108489944	
1000	RST FUTURA	01>	••	108489976			
1000	RSV	98>00	••	108200384	<b>78B40870</b>	108489925	
1000	RSV	01>03	••		<b>78B40870</b>	108489925	

**Genuine****Serie Oro****Genuine****Serie Oro****APRILIA**

1000	RSV FACTORY	03>07	••		<b>78B40870</b>	108489925	
1000	RSV R	00	••	108200384	<b>78B40870</b>	108489925	
1000	RSV R	01>08	••		<b>78B40870</b>	108489925	
1000	RSV4 FACTORY	09>	••		<b>78B40870</b>	108489925	
1000	RSV4 R	10>	••		<b>78B40870</b>	108489925	
1000	RSV SP	99>00	••	108200384	<b>78B40870</b>	108489925	
1000	SL FALCO	00>04	••	108200384	<b>78B40870</b>	108489925	
1000	TUONO	03>	••		<b>78B40870</b>	108489925	
1000	TUONO FIGHTER	02>05	••		<b>78B40870</b>	108489925	
1000	TUONO R	03>09	••		<b>78B40870</b>	108489925	
1000	TUONO RACING	04>05	••		<b>78B40870</b>	108489925	

**ATALA**

50	AT 18	98	•		68B40716		
50	BYTE	97>00	•		68B40710		
50	CAROSSELLO AT 15	97>	•		68B40736		
50	HACKER AT 12	96>	•		68B40716		
50	SKEGGIA	99>	•		68B40716		

**AXY**

125	GULP	08>	•		68B40740		68B40740
125	YUK	07>	•		68B40740		68B40740
150	GULP	08>	•		68B40740		68B40740
150	YUK	07>	•		68B40740		68B40740
200	GULP	08>	•		68B40740		68B40740
200	YUK	07>	•		68B40740		68B40740
300	ROAR	08>	•		68B40740		68B40740

**BENELLI**

50	491 ARMY/RACING/SUPERBIKE	97>	•		68B40716		68B40716
50	491 GT/SPORT	97>	•		68B40716		68B40716
50	491 NAKED	99>	•		68B40716		
50	491 ST	01>	•		68B40716		
50	K2 ARIA-KAT-ACQUA	98>	•		68B40716		
50	K2 NAMUR	99>	•		68B40716		
50	PEPE	99>	•		68B40739		
100	K2 ARIA	99>	•		68B40716		
100	NAKED	99>02	•		68B40716		
100	PEPE	99>	•		68B40739		
125	ADIVA	00>	•		68B40739		
125	CAFFE' NERO	08>	•				
125	VELVET	99>04	•		68B40739		68B40735
125	VELVET TOURING	01>	•		68B40739		68B40735
150	ADIVA	00>	•		68B40739		
150	VELVET	00>04	•		68B40739		68B40735
150	VELVET TOURING	01 >	•		68B40739		68B40735
250	VELVET	99>	•		68B40773		68B40735
250	VELVET TOURING	01>	•		68B40773		68B40735
400	VELVET	03>	•		68B40773		68B40735
900	TORNADO 3 BIPOSTO	02>03	••	108200370	<b>78B40870</b>	208200040	
900	TORNADO 3 L.E.	03>06	••	108200370	<b>78B40870</b>	108489925	
900	TORNADO 3 RS	04>06	••	108200370	<b>78B40870</b>	108489925	
1100	TNT	04	••	108200370	<b>78B40870</b>		68B40781
1130	TNT	05>06	••	108200370	<b>78B40870</b>		68B40781
1130	TNT CAFE' RACER	05>07	••	108200370	<b>78B40870</b>		68B40781
1130	TNT RS	05>06	••	108200370	<b>78B40870</b>		68B40781
1130	TNT SPORT	05>	••	108200370	<b>78B40870</b>		68B40781
1130	TNT TITANIUM	05>07	••	108200370	<b>78B40870</b>		68B40781
1130	TORNADO TRE	06	••	108200370	<b>78B40870</b>		68B40781
1130	TRE-K	06>07	••	108200370	<b>78B40870</b>		68B40781

**BETA**

50	ARK	96>98	•		68B40716		68B40716
50	ARK	99>	•		68B40717		68B40716
50	CHRONO "13"	94>	•		68B40716		
50	EIKON	99>	•		68B40716		68B40716
50	QUADRA	97	•		68B40716		68B40716
50	QUADRA	95>96	•		68B40716		
50	TEMPO "16"	00>	•		68B40738		
125	EIKON	00	•		68B40730		68B40716
150	EIKON	00	•		68B40730		68B40716



**Genuine      Serie Oro      Genuine      Serie Oro**

**BETA**

250	RR	05>09	•				68B40789
400	RR	05>10	•				68B40789
450	RR	05>10	•				68B40789
520	RR	10	•				68B40789
525	RR	05>09	•				68B40789

**BIMOTA**

400	YB7	89	••		<b>78B40870</b>		
500	V-DUE	97>00	••		<b>78B40870</b>		
650	BB1 SUPERMONO	96>00	••		<b>78B40870</b>		
851	TESI 1D 851	90>91	••		<b>78B40870</b>	108265615	
904	DB2 SR	93>00	••		<b>78B40870</b>	108265615	
904	DB3 MANTRA	95>00	••		<b>78B40870</b>		
904	DB4	98>99	••		<b>78B40870</b>		
1000	DB5	05>	••	108200370	<b>78B40870</b>		
1000	DB6 DELIRIO	06>	••	108200370	<b>78B40870</b>		
1000	DIECI BIPOSTO	92>95	••		<b>78B40870</b>		
1000	SB8K GOBERT	04>06	••	108200384	<b>78B40870</b>		
1000	SB8R (SB8R/E11/0012)	97>00	••		<b>78B40870</b>		
1100	SB6	96>00	••		<b>78B40870</b>		
1100	SB6R	98>00	••		<b>78B40870</b>		
1100	SB8K SANTAMONICA	04>	••	108200370	<b>78B40870</b>		

**BMW**

-	SERIE R ALL MODEL (PINZA ATE)	76>80	••			68B407B1	
-	SERIE R ALL MODEL (PINZA BB)	81>84	••			68B407B1	
650	F 650	93>01	•	208489955			68B40781
650	F 650 CS	02>07	•	208489955			68B40781
650	F 650 DAKAR	00>02	•	208489955			68B40781
650	F 650 FL	93>00	•	208489955			68B40781
650	F 650 GS/ABS	00>07	•	208489955			68B40781
650	F 650 GS/ABS	08>	•	208489955			68B407C0
650	F 650 STRADA/ST	97>01	•	208489955			68B40781
650	G 650 X CHALLENGE/COUNTRY	07>09	•	208489955			68B40781
650	G 650 X MOTO	07>09	•		<b>78B40870</b>		68B40781
650	R 65 RT	85>95	•		68B407D2		
750	K 75 (NO ABS)	84>96	••		68B407D2		68B407D3
750	K 75 C	85>91	••		68B407D2		
750	K 75 RT	90>96	••		68B407D2		68B407D3
750	K 75 S	85>88	••		68B407D2		68B407D3
750	K 75 S	89>92	••		68B407D2		
750	K 75 S	93>96	••		68B407D2		68B407D2
800	F 800 GS	09>	••	208489955			68B407C0
800	F 800 R	09>	••		68B407D7		68B407C0
800	F 800 S	06>07	••		68B407D6		68B407C0
800	F 800 S	08>09	••		68B407D7		68B407C0
800	F 800 ST	06>07	••		68B407D6		68B407C0
800	F 800 ST	08>09	••		68B407D7		68B407C0
800	R 80	81>95	••		68B407D2		
800	R 80 GS	81>86	•				
800	R 80 GS	87>	•		<b>78B40816</b>		
800	R 80 PD	91>95	•		<b>78B40816</b>		
800	R 80 R	91>95	••		68B407D2		
800	R 80 RT	83>95	••		68B407D2		
850	R 850 C	98>01	•		68B407D6		68B407C8
850	R 850 GS	98>07	•		68B407D6		68B407C8
850	R 850 R	94>01	•				68B407C8
850	R 850 R	02>07	•		68B407D6		68B407C8
850	R 850 R, ROADSTER	95>00	••				68B407C8
850	R 850 RT ABS	95>01	•				68B407C8
850	R 850 RT	02>04	•		68B407D7		68B407C8
1000	K 1	89>93	••				68B407D3
1000	K 100 (NO ABS)	83>89	••		68B407D2		68B407D3
1000	K 100 LT ABS	90>91	•		68B407D2		68B407D3
1000	K 100 RS	83>91	•		68B407D2		68B407D3
1000	K 100 RS 16 V	89>93	•				68B407D3
1000	K 100 RT	84>89	•		68B407D2		68B407D3
1000	R 100	76>83	•		68B407B1		
1000	R 100 CS	76>80	•		68B407B1		

**Genuine****Serie Oro****Genuine****Serie Oro****BMW**

1000	R 100 GS	87>95	•		68B407D2		
1000	R 100 PD	91>95	•		68B407D2		
1000	R 100 R	91>96	••		<b>78B40816</b>		68B407C8
1000	R 100 RS	85>95	••		<b>78B40816</b>		
1000	R 100 RT	85>95	••		<b>78B40816</b>		
1100	K 1100 LT	91>99	••				68B407D3
1100	R 1100 GS	94>01	••		68B407D6		68B407C8
1100	R 1100 R	95>01	••				68B407C8
1100	R 1100 R ROADSTER	95>00	••				68B407C8
1100	R 1100 RS	85>95	••		<b>78B40816</b>		68B407C8
1100	R 1100 RT	96>01	••		<b>78B40816</b>		68B407C8
1100	R 1100 S	98>00	••		68B407D6		68B407C8
1100	R 1100 S	01>06	••		68B407D7		68B407C8
1100	R 1100 S BOXER	03>06	••		68B407D7		68B407C8
1150	R 1150 GS	99>04	••		68B407D6		68B407C8
1150	R 1150 GS ADVENTURE	02>05	••		68B407D6		68B407C8
1150	R 1150 R	01>06	••		68B407D7		68B407C8
1150	R 1150 ROCKSTER	03>06	••		68B407D7		68B407C8
1150	R 1150 RS	01>05	••		68B407D7		68B407C8
1150	R 1150 RT	01>05	••		68B407D7		68B407C8
1200	HP2 ENDURO	06>09	••		68B407D6		68B407C0
1200	HP2 MEGAMOTO	07>09	••		68B407D7		68B407C0
1200	HP2 SPORT	08>09	••		68B407D7		68B407C0
1200	K 1200 GT	02>	••		68B407D7		
1200	K 1200 LT	99>01	••		68B407D6		
1200	K 1200 LT	02>	••		68B407D7		
1200	K 1200 R	05>08	••		68B407D7		68B407C0
1200	K 1200 R SPORT	07>	••		68B407D7		68B407C0
1200	K 1200 RS	97>00	••		68B407D6		
1200	K 1200 RS	01>	••		68B407D7		
1200	K 1200 S/ABS	05>07	••		68B407D7		68B407C0
1200	R 1200 CRUISER	97>01	••		68B407D6		
1200	R 1200 C CLASSIC	03>	••		68B407D6		
1200	R 1200 CL	02>06	••		68B407D6		
1200	R 1200 GS/ABS	04>09	••		68B407D6		68B407C0
1200	R 1200 GS ADVENTURE	06>09	••		68B407D6		68B407C0
1200	R 1200 R	06>09	••		68B407D7		68B407C0
1200	R 1200 RT	05>09	••		68B407D7		68B407C0
1200	R 1200 S	06>07	••		68B407D6		68B407C0
1200	R 1200 S	08>	••		68B407D7		68B407C0
1200	R 1200 ST	05>08	••		68B407D7		68B407C0
1300	K 1300 GT	09>	••		68B407D7		
1300	K 1300 R/ABS	09>	••		68B407D7		68B407C0
1300	K 1300 S	09>	••		68B407D7		68B407C0

**BS VILLA**

50	AX	93>	•		68B40710		
50	GZ	93>	•		68B40710		
50	ZX	93>	•		68B40710		

**CAGIVA**

50	CITY	92>94	•		68B40711		
50	CITY LUCKY	95>	•		68B40711		
80	CITY	93>	•		68B40711		
125	MITO	90>91	•		<b>78B40870</b>		
125	MITO	91>94	•		<b>78B40870</b>		
125	MITO 2	92>	•	108489982	<b>78B40870</b>		
125	MITO EV	95>07	•		<b>78B40870</b>		
125	MITO 525	06>07	•		<b>78B40870</b>		
125	PLANET	97>03	•	108489982	<b>78B40870</b>		
125	PLANET	04>07	•		<b>78B40870</b>		
125	RAPTOR	04>06	•	108489982	<b>78B40870</b>		
125	SUPERCITY	92>00	•	108489982	<b>78B40870</b>		
500	RIVER	99>01	••	108489982	<b>78B40870</b>		
600	RIVER	95>97	•	108489982	<b>78B40870</b>		
650	RAPTOR	00>	••	108489975			
650	V-RAPTOR	01>	••	108489975			
750	ELEFANT	94>95	•			108489952	68B40780
900	ELEFANT I.E.	90>96	••			108489952	68B40780



	<b>Genuine</b>	<b>Serie Oro</b>		<b>Genuine</b>	<b>Serie Oro</b>		

**CAGIVA**

900	GRAN CANYON	99>04	••			108489952	68B40780
1000	RAPTOR	00>	••	108489975			
1000	V-RAPTOR	01>	••	108489975			
1000	XTRA RAPTOR	02>	••	108489975			

**CCM**

644	DS	02>06	•				68B40752
644	R30	02>06	•				68B40752

**DAELIM**

50	MESSAGE II	98>	•		68B40711		
50	VIVO	99>	•		68B40711		
100	DELFINO	99>	•		68B40711		

**DERBI**

50	GP1	01>02	•				68B40713
50	GP1 REPLICA	01>02	•				68B40713
50	VAMOS	95>97	•		68B40710		
125	PREDATOR	99	•		68B40730		68B40713
125	RAMBLA	09>	•		68B407B0		
180	PREDATOR	99	•		68B40730		68B40713
250	RAMBLA	09>	•		68B407B0		

**DUCATI**

350	350 SUPERSPORT	91>92	•	108489982	<b>78B40870</b>		68B40791
400	M400	95>97	•	108489982	<b>78B40870</b>		68B40791
400	M400	01>06	•	108489993	<b>78B40870</b>		68B40791
400	M400 DARK	03>	••	108489993	<b>78B40870</b>		68B40791
400	400 SUPERSPORT	93>97	•	108489982	<b>78B40870</b>		68B40791
600	M600	93>	•	108489982	<b>78B40870</b>		68B40791
600	M600/DARK	98	•	108489982	<b>78B40870</b>		68B40791
600	M600 DARK CITY	99	•	108489982	<b>78B40870</b>		68B40791
600	M600 METALLIC/DARK/DARK CITY	00>01	•	108489993	<b>78B40870</b>		68B40791
600	600 SUPERSPORT	91>00	•	108489982	<b>78B40870</b>		68B40791
620	M620 I.E. DARK SD	04>05	•	108489993	<b>78B40870</b>		68B40791
620	M620 S I.E.	02>04	••	108489993	<b>78B40870</b>		68B40791
620	M620 I.E.	05>06	••		<b>78B40850</b>		68B40791
620	MULTISTRADA 620 BIDISCO	04>	••		<b>78B40850</b>		68B40791
620	MULTISTRADA 620 SD	04>	•	108489993	<b>78B40870</b>		68B40791
620	SPORT	03>04	•		<b>78B40870</b>		68B40791
620	SUPERSPORT	02>05	••	108489993	<b>78B40870</b>		68B40791
695	MONSTER 695	07	••		<b>78B40850</b>		68B40791
696	MONSTER 696/ABS	08>10	••	108489998	<b>78B40870</b>		68B40791
748	748	00>02	••	108489993	<b>78B40870</b>	108489924	
748	748 BIPOSTO	95>98	••	108489982	<b>78B40870</b>	108489924	
748	748 BIPOSTO	99>02	••	108489993	<b>78B40870</b>	108489924	
748	748 R	00	••	108489991	<b>78B40870</b>	108489924	
748	748 R	01>03	••		<b>78B40870</b>	108489924	
748	748 S	00>02	••	108489991	<b>78B40870</b>	108489924	
748	748 SP	95>97	••		<b>78B40870</b>	108489924	
748	748 SPS	98>99	••		<b>78B40870</b>	108489924	
749	749/DARK/R/S	03>07	••		<b>78B40880</b>		68B40768
750	M750 BIDISCO	96>97	••	108489982	<b>78B40870</b>		68B40791
750	M750 MONODISCO	96>97	•	108489982	<b>78B40870</b>		68B40791
750	M750	98>99	••	108489982	<b>78B40870</b>		68B40791
750	M750/DARK/METALLIC	00>01	••	108489993	<b>78B40870</b>		68B40791
750	M750 DARK I.E.	02	••	108489993	<b>78B40870</b>		68B40791
750	750 SPORT	01>02	••	108489993	<b>78B40870</b>		68B40791
750	750 SUPERSPORT	91>99	•	108489982	<b>78B40870</b>		68B40791
750	750 SUPERSPORT I.E.	00>02	••	108489993	<b>78B40870</b>		68B40791
796	MONSTER	10>	••		<b>78B40878</b>		68B40792
796	MONSTER ABS	10>	••		<b>78B40878</b>		68B40792
796	HYPERMOTARD	10>	••		<b>78B40845</b>		68B40792
800	M800 S I.E.	03>04	••	108489993	<b>78B40870</b>		68B40791
800	MS2R/DARK	05>06	••		<b>78B40850</b>		68B40792
800	800 SPORT	03>04	••		<b>78B40870</b>		68B40791
800	800 SUPERSPORT/S	03>04	••	108489993	<b>78B40870</b>		68B40791
800	800 SUPERSPORT	06	••	108489993	<b>78B40870</b>		68B40791
848	848	08>	••		<b>78B40880</b>		68B40792
851	851	89>91	••	108489982	<b>78B40870</b>		68B40791
851	851 SP 5	93	••		<b>78B40870</b>		68B40791



Genuine

Serie Oro

Genuine

Serie Oro

**DUCATI**

851	851 SP III	91	••	108489982	<b>78B40870</b>		68B40791
851	851 SP4	92	••		<b>78B40870</b>		68B40791
851	851 SP11	90	••		<b>78B40870</b>		68B40791
888	888 SP	90>93	••		<b>78B40870</b>		68B40791
888	888 SUPERBIKE STRADA	94>95	••	108489982	<b>78B40870</b>		68B40791
900	M900	93>99	••		<b>78B40870</b>		68B40791
900	M900 I.E.	00	••	108489993	<b>78B40870</b>		68B40791
900	M900 CROMO	98	••	108489982	<b>78B40870</b>		68B40791
900	M900 CROMO I.E.	00>01	••	108489993	<b>78B40870</b>		68B40791
900	M900 DARK CITY	99	••	108489982	<b>78B40870</b>		68B40791
900	M900 DARK I.E.	00>02	••	108489993	<b>78B40870</b>		68B40791
900	M900 METALLIC I.E.	00>01	••	108489993	<b>78B40870</b>		68B40791
900	M900 S I.E.	00>01	••	108489993	<b>78B40870</b>		68B40791
900	M900 SPECIAL	98	••	108489982	<b>78B40870</b>		68B40791
900	MH EVOLUTION	01>02	••	108489998	<b>78B40870</b>	108489924	
900	SL SUPERLIGHT	92	••		<b>78B40870</b>		68B40791
900	SL SUPERLIGHT	93>97	••	108489982	<b>78B40870</b>		68B40791
900	SPORT	02	••		<b>78B40870</b>		68B40791
900	900 SS	89>90	••		<b>78B40870</b>		68B40791
900	900 SS	91>99	••	108489982	<b>78B40870</b>		68B40791
900	900 SS I.E.	00>02	••	108489993	<b>78B40870</b>		68B40791
900	900 SS S I.E.	02	••	108489993	<b>78B40870</b>		68B40791
907	907 I.E.	90>91	••				68B40791
907	907 I.E.	92>93	••	108489982	<b>78B40870</b>		68B40791
916	916	94>96	••	108489982	<b>78B40870</b>	108489924	
916	916 BIPOSTO/SENNA	94>98	••	108489982	<b>78B40870</b>	108489924	
916	916 RACING	94>97	••		<b>78B40870</b>	108489924	
916	916 S/916 SP	94>96	••		<b>78B40870</b>	108489924	
916	916 SPS	97>98	••		<b>78B40870</b>	108489924	
916	M S4	01	••	108489982	<b>78B40870</b>		68B40791
916	M S4	02>03	••	108200384	<b>78B40870</b>		68B40791
916	M S4 FOGGY	02>	••	108200384	<b>78B40870</b>		68B40791
916	ST4	99	••	108489982	<b>78B40870</b>		68B40791
916	ST4	00>04	••	108200384	<b>78B40870</b>		68B40791
916	ST4 S	03>	••	108200384	<b>78B40870</b>		68B40791
944	ST2	97>99	••	108489982	<b>78B40870</b>		68B40791
944	ST2	00>03	••	108489993	<b>78B40870</b>		68B40791
996	996 S/SPS/SPS II/SPS III	99>01	••	108489991	<b>78B40870</b>	108489924	
996	996 R	01	••	108200370	<b>78B40870</b>	108489924	
996	ST4 S	01>05	••		<b>78B40870</b>		68B40791
998	998/F.E./MATRIX	02>	••	108200370	<b>78B40870</b>	108489924	
998	998 R/S	02>	••		<b>78B40870</b>	108489924	
999	999/R/S/XEROX	03>07	••		<b>78B40880</b>		68B40768
1000	DESMOSEDICI RR	08>	••		<b>78B40890</b>		68B40768
1000	GT	06>	••	108489998	<b>78B40870</b>		68B40791
1000	M1000 S I.E.	03>	••	108489993	<b>78B40870</b>		68B40791
1000	MS2R	03>05	••		<b>78B40850</b>		68B40791
1000	MS2R	06>07	••	108489998	<b>78B40870</b>		68B40792
1000	MS2R DARK	06>07	••		<b>78B40850</b>		68B40792
1000	MS4R	03>04	••	108489991	<b>78B40870</b>		68B40792
1000	MS4R (MONOBRACCIO)	05>06	••		<b>78B40870</b>		68B40792
1000	MS4RS	06>	••		<b>78B40880</b>		68B40792
1000	MULTISTRADA/S	03>06	••		<b>78B40882</b>		68B40792
1000	PAUL SMART I.E.	06>07	••	108489998	<b>78B40870</b>		68B40791
1000	1000SS S	03>	••	108489993	<b>78B40870</b>		68B40791
1000	1100SS	03>06	••		<b>78B40870</b>		68B40791
1000	SPORT	06>07	••	108489998	<b>78B40870</b>		68B40791
1000	SPORT S	07>	••	108489998	<b>78B40870</b>		68B40791
1000	ST3	04>06	••		<b>78B40870</b>		68B40791
1098	1098/R/S/TRICOLORE	07>	••		<b>78B40890</b>		68B407E8
1099	STREETFIGHTER/S	09>	••		<b>78B40890</b>		68B407E8
1100	HYPERMOTARD/S/EVO/SP	07>	••		<b>78B40845</b>		68B40792
1100	M1100	09>	••		<b>78B40878</b>		68B40792
1100	M1100 S	09>	••		<b>78B40880</b>		68B40792
1100	MULTISTRADA/S	07>09	••		<b>78B40882</b>		68B40792
1198	1098 R/BAYLISS	09>	••		<b>78B40890</b>		68B407E8
1198	1198/R/S	09>	••		<b>78B40890</b>		68B407E8





				Genuine	Serie Oro	Genuine	Serie Oro
--	--	--	--	---------	-----------	---------	-----------

### DUCATI

1200	MULTISTRADA	10>	••		<b>78B40878</b>		
1200	MULTISTRADA ABS	10>	••		<b>78B40878</b>		

### FANTIC

50	BIG WHEEL	91>94	•		68B40710		
50	FLYING TIGER	96	•		68B40710		
50	GRINTA	95>	•		68B40710		
50	LEADER	95	•	108489930	68B40717		
50	QUEENIE	95	•		68B40710		
50	SPIKE	96	•		68B40711		

### GARELLI

150	MOSQUITO	08>	•		68B40740		68B40740
-----	----------	-----	---	--	----------	--	----------

### GAS GAS

125	EC	96>	•				68B40752
125	MC	96>	•				68B40752
200	HOBBY	07	•				68B40752
200	EC	04>07	•				68B40752
250	EC	96>09	•				68B40752
250	MC	96>09	•				68B40752
300	EC	96>09	•				68B40752
300	MC	96>09	•				68B40752
400	EC	02	•				68B40752
400	EC	06>07	•				68B40752
400	FSE	04>07	•				68B40752
400	MC	02	•				68B40752
400	MC	06>07	•				68B40752
400	PAMPERA	06>07	•				68B40752
450	EC	03>07	•				68B40752
450	FSE	03>07	•				68B40752
450	FSR	07>	•				68B40752
450	MC	03	•				68B40752
450	MC	07	•				68B40752
450	PAMPERA	07>08	•				68B40752

### GILERA

50	DNA	00>	•				68B40776
50	EASY MOVING	97>	•		68B40710		
50	ICE	99>	•		68B40722		
50	RUNNER	01>	•		68B40730		68B40713
50	RUNNER	94>	•		68B40730		
50	RUNNER DD	96>	•		68B40730		68B40713
50	RUNNER PUER JET	03>	•		68B40730		68B40713
50	RUNNER RACING REPLICA	03>	•		68B40730		68B40713
50	RUNNER SP	00>01	•		68B40730		68B40713
50	STALKER	98>	•		68B40717		68B40713
50	STORM	96>01	•	108489930	68B40717		68B40713
50	TYPHOON	96	•	108489930	68B40717		
50	TYPHOON BENETTON	93>95	•	108489930	68B40717		
50	TYPHOON MARTINI	96	•	108489930	68B40717		
50	TYPHOON XR	96	•	108489930	68B40717		
125	DNA	01>	•				68B40776
125	GFR	93>	•	108489982	78B40870		
125	NEXUS	07>	•		68B407B6		68B40777
125	RUNNER	95	•	108489930	68B40717		
125	RUNNER	06>	•		68B40730		68B40776
125	RUNNER FX	97>00	•		68B40730		68B40776
125	RUNNER FX	01>05	•		68B40730		68B40776
125	RUNNER SP	98>	•		68B40730		68B40776
125	RUNNER ST	08>	•		68B40774		68B40776
125	RUNNER VX	99>04	•		68B40730		68B40776
125	RUNNER VX	05>07	•		68B40774		68B40776
125	TYPHOON XR	95>	•	108489930	68B40717		
180	DNA	01>	•		68B40776		68B40776
180	RUNNER FXR	98>	•		68B40730		68B40776
180	RUNNER FXR SP	99>	•		68B40730		68B40776
180	RUNNER SP	98>	•		68B40730		68B40776
180	RUNNER VRX	00>	•		68B40730		68B40776
180	RUNNER VXR	99>	•		68B40730		68B40776
200	HERCULES	02>	•		68B40730		68B40776



Genuine

Serie Oro

Genuine

Serie Oro

**GILERA**

200	RUNNER SP	01>02	•		68B40730		68B40776
200	RUNNER VXR	01>04	•		68B40730		68B40776
200	RUNNER VXR	05>08	•		68B40774		68B40776
250	NEXUS	06>	•		68B407B6		68B40777
500	FUOCO I.E.	07>	•		68B40774		68B40777
500	NEXUS	04>	••		68B407B6		68B40777

**HARLEY DAVIDSON**

883	XL 883 R SPORTSTER	00>03	•		<b>78B40891</b>		
883	XL 883 SPORTSTER CUSTOM	04>08	•		<b>78B40891</b>		<b>78B40828</b>
883	XLH 883	70>84	•		<b>78B40822</b>		68B407E0
883	XLH 883 SPORTSTER	85>99	•		<b>78B40822</b>		
883	XLH 883 SPORTSTER	00>03	•		<b>78B40891</b>		<b>78B40828</b>
883	XLH 883 SPORTSTER	04>06	••		<b>78B40891</b>		<b>78B40828</b>
883	XLH 883 SPORTSTER HUGGER	00>03	•		<b>78B40891</b>		<b>78B40828</b>
883	XLR 883 CUSTOM 53	01>01	•		<b>78B40891</b>		
1000	XL 1000	78>81	•		<b>78B40822</b>		68B407E0
1000	XLS 1000 ROAD STER	79>84	••		<b>78B40822</b>		68B407E0
1200	XL 1200 R	00>06	••		<b>78B40891</b>		
1200	XL 1200 R SPORTSTER ROADSTER	04>06	••		<b>78B40891</b>		
1200	XL 1200 SPORTSTER	04>06	•		<b>78B40891</b>		<b>78B40828</b>
1200	XL 1200 SPORTSTER CUSTOM	00>03	••		<b>78B40891</b>		<b>78B40828</b>
1200	XL 1200 SPORTSTER NIGHTSTER	07>08	•		<b>78B40891</b>		<b>78B40828</b>
1200	XL 1200 SPORTSTER SPORT	00>03	••		<b>78B40891</b>		<b>78B40828</b>
1200	XLH 1200 SPORT	96>99	••		<b>78B40822</b>		
1200	XLH 1200 SPORTSTER	87>99	•		<b>78B40822</b>		
1340	FLH 1340 80	81>84	•		<b>78B40822</b>		68B407E0
1340	FLH 1340 81	87>99	••		<b>78B40822</b>		68B407E0
1340	FLH 1340 82	87>99	••		<b>78B40822</b>		68B407E0
1340	FLH 1340 83	89>99	•		<b>78B40822</b>		68B407E0
1340	FLSTC 1340 HERITAGE SOFTAIL CLAS.	00>02	•		<b>78B40891</b>		<b>78B40828</b>
1340	FLSTC 1340 HERITAGE SOFTAIL CLAS.	89>99	•		<b>78B40822</b>		68B407E0
1340	FLSTC FAT BOY	00>02	•		<b>78B40891</b>		
1340	FLSTC FAT BOY	89>99	•		<b>78B40822</b>		68B407E0
1340	FXDWG DYNA WIDE GLIDE	93>98	•		<b>78B40822</b>		68B407E0
1340	FXLR 1340 LOW RIDER CUSTOM	00>	•		<b>78B40891</b>		<b>78B40828</b>
1340	FXR 1340 SUPER GLIDE	82>99	•		<b>78B40822</b>		68B407E0
1340	FXRL 1340 LOW RIDER CUSTOM	87>99	•		<b>78B40822</b>		68B407E0
1340	FXRS 1340 LOW RIDER SPORT	87>99	•		<b>78B40822</b>		68B407E0
1340	FXRS LOW RIDER SPORT EDITION	87>99	••		<b>78B40822</b>		68B407E0
1340	FXRT 1340 SPORT GLIDE	87>99	••		<b>78B40822</b>		68B407E0
1340	FXSTC 1340 SOFTAIL CUSTOM	89>99	•		<b>78B40822</b>		68B407E0
1340	FXSTS 1340 SPRINGER SOFTAIL	00>02	•		<b>78B40891</b>		<b>78B40828</b>
1340	FXSTS 1340 SPRINGER SOFTAIL	89>99	•		<b>78B40822</b>		68B407E0
1450	FLHR/I ROAD KING	00>04	••		<b>78B40891</b>		
1450	FLHR/I ROAD KING	98>99	••		<b>78B40822</b>		68B407E0
1450	FLHRCI ROAD KING CLASSIC	00>04	••		<b>78B40891</b>		
1450	FLHT/I ELECTRA GLIDE STANDARD	98>99	••		<b>78B40822</b>		68B407E0
1450	FLHT/I ELECTRA GLIDE STANDARD	00>06	••		<b>78B40891</b>		<b>78B40828</b>
1450	FLHTCUI ELECTRA GLIDE ULTRA CLAS.	00>06	••		<b>78B40891</b>		<b>78B40828</b>
1450	FLSTC/I HERITAGE SOFTAIL CLASSIC	00>04	•		<b>78B40891</b>		
1450	FLSTF/I FAT BOY	03>03	•		<b>78B40891</b>		
1450	FLSTS/I HERITAGE SPRINGER	00>03	•		<b>78B40891</b>		<b>78B40828</b>
1450	FLTR/I ROAD GLIDE	98>99	••		<b>78B40822</b>		68B407E0
1450	FLTR/I ROAD GLIDE CLASSIC	00>04	••		<b>78B40891</b>		<b>78B40828</b>
1450	FX DWG DYNA WIDE GLIDE	99	•		<b>78B40822</b>		68B407E0
1450	FXD DYNA SUPER GLIDE	00>03	•		<b>78B40891</b>		<b>78B40828</b>
1450	FXDL DYNA GLIDE LOW RIDER	00>06	••		<b>78B40891</b>		<b>78B40828</b>
1450	FXDS DYNA SUPER GLIDE SPORT	00>06	••		<b>78B40891</b>		<b>78B40828</b>
1450	FXDS DYNA SUPER GLIDE SPORT	98>99	••		<b>78B40822</b>		68B407E0
1450	FXDWG DYNA WIDE GLIDE	00>06	•		<b>78B40891</b>		<b>78B40828</b>
1450	FXRS SPORT GLIDE	84>86	••		<b>78B40822</b>		68B407E0
1450	FXRT TOUR GLIDE	84>86	••		<b>78B40822</b>		68B407E0
1450	FXSTB ICE BOB	00>03	••		<b>78B40822</b>		68B407E0
1450	FXSTB/I NIGHT TRAIN	00>04	•		<b>78B40891</b>		
1450	FXSTC SOFTAIL CUSTOM	00>06	••		<b>78B40891</b>		
1450	FXSTD/I SOFTAIL DEUCE	00>04	•		<b>78B40891</b>		
1450	FXSTS/I SPRINGER SOFTAIL	00>06	••		<b>78B40891</b>		



Genuine

Serie Oro

Genuine

Serie Oro

**HARLEY DAVIDSON**

1500	FXDX DYNA SUPER GLIDE T-SPORT	00>06	••		<b>78B40891</b>		<b>78B40828</b>
1500	FXST SOFTAIL STANDARD	01>01	•		<b>78B40891</b>		<b>78B40828</b>

**HM MOTO**

125	CR E SUPERMOTARD	00>01	•				68B40786
125	CR E SUPERMOTARD	02>03	•				68B40787
125	CR E SUPERMOTARD	04>08	•				68B40787
230	CR F ENDURO	04>06	•				68B40787
230	CR F SUPERMOTARD	04>06	•				68B40787
250	CR E SUPERMOTARD	00>01	•				68B40786
250	CR E SUPERMOTARD	02>05	•				68B40787
250	CR E SUPERMOTARD	06>09	•				68B40787
250	CRE F	04>09	•		68B40796		68B40787
250	CRE X	04>09	•		68B40796		68B40787
250	CRF R SUPERMOTARD	04>08	•				68B40787
250	CRF X SUPERMOTARD	04>08	•				68B40787
450	CRF R	02>	•		68B40796		68B40786
450	CRF R SUPERMOTARD	02>03	•				68B40787
450	CRF X SUPERMOTARD	04>09	•				68B40787

**HONDA**

50	BALI SJ	94>	•		68B40716		
50	CRM	97>02	•		68B40769		
50	GP DIO	94>	•		68B40711		
50	HM MOTO	95>	•		68B40767		
50	NS AERO	90>97	•		68B40711		
50	SFX	88>96	•		68B40711		
50	SH 50 FIFTY	96>	•		68B40767		
50	SHADOW	98>99	•		68B40716		
50	SHADOW	00>	•		68B40716		
50	SJ BALI	96>02	•		68B40716		
50	SKY	96>	•		68B40716		
50	SKY ANNIVERSARIO	99>00	•		68B40716		
50	SKY CLASSIC	96>	•		68B40716		
50	SKYCLASSIC-VETRO	00>	•		68B40716		
50	SKY DELUXE	99>02	•		68B40716		
50	SKY STD	97>02	•		68B40716		
50	SKY VETRO	99>01	•		68B40716		
50	SR DIO	90>93	•		68B40711		
50	SR DIO	00>	•		68B40711		
50	SXR	98>00	•		68B40711		
50	SXR SHADOW	90>93	•		68B40711		
50	X8R S/X	98>	•				68B40720
50	ZX DIO	98>	•		68B40711		
75	AX 1	89>	•		68B40769		
75	CRM	95>99	•		68B40769		
75	SHADOW	88>	•		68B40716		
90	SHADOW	98>	•		68B40716		
90	YUPI	98>	•		68B40716		
100	CHIOCCIOLA NES	95	•		68B40740		
100	SH FIFTY	96>	•		68B40767		
100	SJ BALI	95	•		68B40716		
100	SJ BALI	96>	•		68B40716		
110	LEAD	08	•		68B40716		
125	CBR R	03>07	•		68B407E9		68B40740
125	CHIOCCIOLA @	01>	•		68B40740		
125	CR E	88	•		68B40769		
125	CR E	92>94	•		68B40769		
125	CR E	95>97	•		68B40796		
125	CR E	98>01	•		68B40796		68B40786
125	CR E	02>08	•		68B40796		68B40787
125	CR R	88	•		68B40769		
125	CR R	92>94	•		68B40769		
125	CR R	95>97	•		68B40796		
125	CR R	98>01	•		68B40796		68B40786
125	CR R	02>08	•		68B40796		68B40787
125	CRM	98	•		68B40769		
125	CR F SUPERMOTARD	00>05	•				68B40786
125	DYLAN	00>07	•		68B40740		



Genuine

Serie Oro

Genuine

Serie Oro

HONDA

125	PANTHEON	98>02	•		68B40775		
125	PANTHEON FES	03>07	•		68B40775		68B40749
125	PS I	06>08	•		68B40740		
125	S-WING	07>	•		68B40775		68B40749
125	SH / SH INIEZIONE	98>08	•		68B40740		
125	SH ED	09>	••		68B40775		68B40775
125	SPACY	96>01	•		68B40716		
125	VARADERO	01>	•				68B40740
125	XLR R	98>00	•		68B40769		
150	CRF F	03>	•		68B40769		
150	CHIOCCIOLA @	01>06	•		68B40740		
150	DYLAN	00>07	•		68B40740		
150	PANTHEON	98>02	•		68B40775		
150	PANTHEON FES	03>07	•		68B40775		68B40749
150	PS I	06>08	•		68B40740		
150	S-WING	07>	•		68B40775		68B40749
150	SH / SH INIEZIONE	98>08	•		68B40740		
150	SH ED	09>	••		68B40775		68B40775
230	CRF ENDURO	04>06	•		68B40796		
230	CRF TRIAL	04>06	•		68B40769		
230	SL	98	•		68B40769		
250	CB	91>06	•		68B40775		68B40780
250	CN	88>	•		68B40720		
250	CR E	88	•		68B40769		
250	CR E	92>94	•		68B40769		
250	CR E	95>96	•		68B40796		
250	CR E	97>01	•		68B40796		68B40786
250	CR E	02>08	•		68B40796		68B40787
250	CR R	88	•		68B40769		
250	CR R	92>94	•		68B40769		
250	CR R	95>96	•		68B40796		
250	CR R	97>01	•		68B40796		68B40786
250	CR R	02>08	•		68B40796		68B40787
250	CR F SUPERMOTARD	00>05	•				68B40786
250	CRF R	04>10	•		68B40796		68B40787
250	CRF X	04>07	•		68B40796		68B40787
250	CRF X	08>09	•				68B40787
250	CRM R	98	•		68B40769		
250	FORESIGHT	97>99	•		68B40775		
250	FORESIGHT	00>07	•		68B40775		68B40749
250	FORZA	00>04	•		68B40775		68B40749
250	FORZA X / XE	05>07	•		68B40775		68B40780
250	FORZA X / XE	08>	•		68B407A6		68B40780
250	HORNET	97>	•				68B40749
250	JAZZ	00>04	•		68B40775		68B40749
250	NX L	-	•		68B40769		
250	VTR	98>	•				68B40749
250	XELVIS	97>98	•				68B40749
250	XL R BAJA	88>91	•		68B40769		68B40748
250	XL R BAJA	96	•				68B40740
250	XR - R	97	•		68B40769		68B40740
250	XR - R	98>00	•		68B40769		68B40740
250	XR - R	01>	•				68B40740
300	SH 300 I.	06>09	•		68B407A6		68B407A6
350	CB S-G	87>	•		68B407A5		
400	CB	89>91	•				68B40749
400	CB FOUR	97>	•		<b>78B40827</b>		
400	CB N	82>88	••				68B40749
400	CBR RR	89>90	•				68B40743
400	NSR	85>88	•		68B407A6		68B40743
400	SILVER WING	06>08	••		68B407A6		68B40780
400	SW - T 400	09>	••		68B407E7		68B40797
400	VFR R	86>88	•		68B407E9		68B40743
400	XR - R	95>05	•		68B40769		68B40740
400	XR - R	06>07	•				68B40740
400	XR - R SUPERMOTARD	00>07	•				68B40740
440	XR - R	06>07	•				68B40740

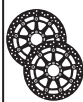

Genuine

Serie Oro

Genuine

Serie Oro

## HONDA

440	XR - R SUPERMOTARD	06>07	•				68B40740
450	CB S	85>89	••		68B407A5		
500	CR	88	•		68B40769		
500	CR	92>94	•		68B40769		
450	CR F SUPERMOTARD	02>03	•				68B40786
450	CR F SUPERMOTARD	04>	•				68B40786
450	CRF R	02>10	•		68B40796		68B40787
450	CRF X	04>09	•		68B40796		68B40787
500	CB	95>03	••				68B40780
500	CBF	04>08	••				68B40783
500	CB S	98>02	••				68B40780
500	CR E	95>01	•		68B40796		
500	CR R	95>01	•		68B40796		
500	VF F-F2	83>87	•		68B407A6		
500	XR	91>93	•				68B40740
600	CBR F	87>90	•		68B407E9		68B40743
600	CBR F	91>94	•		68B407E9		68B40749
600	CBR F	95>98	•				68B40749
600	CBR F	99>00	••		<b>78B40825</b>		68B40749
600	CBR F	01>02	••				68B40749
600	CBR F SPORT	01>02	••		<b>78B40823</b>		68B40749
600	CBR F3	03	••		<b>78B40825</b>		68B40749
600	CBR F4	01>06	••		<b>78B40823</b>		68B40749
600	CBR RR	03>	••		<b>78B40867</b>		68B40749
600	CBR RR ABS	09>	••		<b>78B40867</b>		68B40749
600	HORNET	98>99	••		<b>78B40827</b>		68B40749
600	CB-F HORNET/S	00>06	••		<b>78B40826</b>		68B40749
600	HORNET	07>	••		<b>78B40824</b>		68B40783
600	HORNET ABS/CBS	07>	••		<b>78B40824</b>		68B40783
600	SILVER WING	00>06	•		68B407A6		68B40780
600	SILVER WING	07>	•		68B407E9		68B40780
600	SILVER WING ABS	03>	•		68B407E9		68B40780
600	XL V TRANSALP	87>90	•		68B407E9		
600	XL V TRANSALP	91>93	•		68B407E9		68B40780
600	XL V TRANSALP VR/VT	94>96	•		68B407E9		68B40780
600	XL V TRANSALP	97>99	••		68B407A5		68B40780
600	XL-R	83>87	•		68B40769		
600	XR-R	88>99	•		68B40769		68B40740
600	XR R DAKAR	99	•		68B40769		68B40740
650	FMX	05>06	•				68B40749
650	NX DOMINATOR	88>92	•		68B407A5		68B40749
650	NX DOMINATOR	93>04	•		68B407A5		68B40748
650	SLR	97>99	•		68B407E9		68B40748
50	VIGOR FX	99>01	•		68B407E9		68B40748
650	XL V TRANSALP	00>07	••		68B407A5		68B40780
650	XR L	93>08	•		68B407A5		68B40749
650	XR-R	00>03	•		68B40769		
650	XR-R	97>99	•				68B40749
650	XRV AFRICA TWIN	88>89	•				68B40780
680	XL 700 V TRANSALP/ABS	08>09	••		68B407A5		68B40780
750	CB SEVEN-FIFTY	92>95	••				68B40780
750	CBX F	84>88	••		68B407E9		
750	VFR F	85>87	••		68B407E9		68B407A6
750	VFR F	88>89	••				68B407A6
750	XLV R	83>87	•		68B407E9		
750	XRV AFRICA TWIN	90>02	••		68B407C7		
800	VFR INTERCEPTOR	98>	••		<b>78B40825</b>		
900	CBR RR	92>93	••		<b>78B40825</b>		68B40749
900	CBR RR	94>03	••				68B40749
900	HORNET	02>06	••		<b>78B40823</b>		68B40780
929	CBR RR	99>01	••				68B40749
954	CBR RR	02>03	••				68B40749
1000	CBF/ABS	06>08	••				68B40783
1000	CB R	08>	••		<b>78B40867</b>		68B40749
1000	CB R ABS	09>	••		<b>78B40867</b>		68B40749
1000	CBR F	93>97	••				68B407A6
1000	CBR RR	04>05	••		<b>78B40867</b>		68B40749



Genuine

Serie Oro

Genuine

Serie Oro

**HONDA**

1000	CBR RR	06>07	••		<b>78B40877</b>		68B40749
1000	CBR RR	08>	••		<b>78B40876</b>		68B40749
1000	CBR RR - ABS	09>	••		<b>78B40876</b>		68B40749
1000	VF F	84>88	••		68B407E9		
1000	VF R	86>87	••		68B407E9		
1000	VTR F	97>07	••				68B40749
1000	VTR SP1	00>01	••		<b>78B40877</b>		68B40749
1000	VTR SP2	02>04	••		<b>78B40877</b>		68B40749
1000	XL-V VARADERO	99>	••		<b>78B40825</b>		
1100	CBR XX	97>04	••				68B407A6
1100	CB X 11	00>03	••				68B407A6
1300	CB	03>	••		<b>78B40867</b>		68B407A6
1500	GL F6C VALKYRIA	97>03	••		<b>78B40825</b>		

**HYOSUNG**

50	PLUS	95>	•		68B40714		
50	SUPER CAB	95>	•		68B40714		
50	SUPER CAB PLUS	98>	•		68B40714		

**HUSABERG**

390	FE	10>	•		68B407B8		68B40752
400	FE	00>03	•		68B407B8		68B40752
400	FE E	01>03	•		68B407B8		68B40752
400	FS C	01>03	•		68B407B8		68B40752
400	FS E	01>03	•		68B407B8		68B40752
450	FE	10>	•		68B407B8		68B40752
450	FS E	03>08	•				68B40752
450	FX E	10	•		68B407B8		68B40752
470	FC E	01>02	•		68B407B8		
501	CR	99>03	•		68B407B8		
501	FC	99>03	•		68B407B8		68B40752
501	FE E	99>04	•		68B407B8		68B40752
501	FE S	99>04	•		68B407B8		68B40752
550	FC E	01>05	•		68B407B8		68B40752
550	FE E	04>08	•		68B407B8		68B40752
570	FE	10>	•		68B407B8		68B40752
570	FS	10>	•				68B40752
600	FC	99>03	•		68B407B8		68B40752
600	FE E	99>02	•		68B407B8		68B40752
600	FE SUPERMOTARD	99>03	•				68B40752
650	FE E	01>08	•		68B407B8		68B40752
650	FS E,C	01>08	•				68B40752
650	FX E	01>05	•		68B407B8		68B40752

**HUSQVARNA**

125	CR	00>04	•		<b>78B40814</b>		68B40754
125	CR	05>10	•		<b>78B40814</b>		68B40789
125	SM	00>	•		<b>78B40814</b>		68B40754
125	SM S	03>09	•		<b>78B40814</b>		68B40754
125	WR	00>	•		<b>78B40814</b>		68B40754
125	WR	00>05	•		<b>78B40814</b>		68B40754
125	WR	09>10	•		<b>78B40814</b>		68B40789
125	WR E	00>09	•		<b>78B40814</b>		68B40754
250	CR	00>04	•		<b>78B40814</b>		68B40754
250	CR	05>10	•		<b>78B40814</b>		68B40789
250	TC	04>10	•		<b>78B40814</b>		68B40789
250	TE	04>10	•		<b>78B40814</b>		68B40754
250	WR	00>06	•		<b>78B40814</b>		68B40754
250	WR	07>10	•		<b>78B40814</b>		68B40789
360	WR	00>04	•		<b>78B40814</b>		68B40754
410	TE	00>01	•		<b>78B40814</b>		68B40754
450	SMR	03>05	•	108489966			68B40754
450	SMR	06>08	•				68B40789
450	TC	02>03	•		<b>78B40814</b>		68B40754
450	TC	04>10	•		<b>78B40814</b>		68B40789
450	TE	02>06	•		<b>78B40814</b>		68B40754
450	TE	07>10	•		<b>78B40814</b>		68B40789
510	SMR	05	•	108489996			68B40754
510	SMR	06>08	•				68B40789
510	TC	02>04	•		<b>78B40814</b>		68B40754

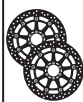
**Genuine****Serie Oro****Genuine****Serie Oro****HUSQVARNA**

510	TC	05>09	•		<b>78B40814</b>		68B40789
510	TE	02>04	•		<b>78B40814</b>		68B40754
510	TE	05>10	•		<b>78B40814</b>		68B40789
510	TE CENTENNIAL	04>	•		<b>78B40814</b>		68B40754
570	SM R	00>	•				68B40754
570	SM R	01>04	•	108489996			68B40754
570	TC	00>03	•		<b>78B40814</b>		68B40754
570	TE	01>04	•		<b>78B40814</b>		68B40754
610	LT	00>	•	108489996			
610	SM	05	•	108489996			
610	SM	98>99	•	108489996			
610	SM S	00>04	•	108489996			
610	TC	00>04	•		<b>78B40814</b>		68B40754
610	TE	00>04	•		<b>78B40814</b>		68B40754
610	TE E	05>	•		<b>78B40814</b>		68B40754
630	SM R	03>05	•	108489966			68B40754

**ITALJET**

50	BAZOOKA	92>97	•			68B40710	
50	CRUISE	94>	•			68B40711	
50	PISTA	93>	•			68B40710	
50	SCOOP	93	•			68B40710	
50	YANKEE	93>	•			68B40710	
125	DRAGSTER	99>01	•				68B40776
180	DRAGSTER	99>01	•				68B40776
250	JUPITER	00>	•	108200045		68B40791	68B40762

**KAWASAKI**

125	KX	88>02	•				68B40746
125	KX	03>05	•		<b>78B40810</b>		68B40782
125	KX	06>08	•		<b>78B40811</b>		68B40782
200	KDX	04>06	•				68B40746
220	KDX	03>05	•				68B40746
250	KX	87>02	•				68B40746
250	KX	03>05	•		<b>78B40810</b>		68B40782
250	KX	06>08	•		<b>78B40811</b>		68B40782
250	KXE F	06>07	•		<b>78B40811</b>		
250	KX F	04>05	•		<b>78B40810</b>		68B40782
250	KX F	06>10	•		<b>78B40811</b>		68B40782
250	ZZR	92>	•		<b>78B40841</b>		
300	KLX	96>07	•				68B40746
400	ZXR	89>90	•		<b>78B40841</b>		
400	ZXR	91>02	•				68B40779
450	KLX R	06>09	•		<b>78B40811</b>		68B40782
450	KX F	06>10	•		<b>78B40811</b>		68B40782
450	KXE F	06>07	•		<b>78B40811</b>		
500	KX	90>04	•				68B40746
550	ZR ZEPHYR	93>01	•		<b>78B40841</b>		68B40779
600	ELIMINATOR	95>99	•		<b>78B40841</b>		
600	ER 6F/ABS	06>	••				68B40747
600	ER 6N/ABS	06>	••				68B40747
600	ZX-6R	95>97	••		<b>78B40841</b>		68B40761
600	ZX-6R	98>02	••		<b>78B40841</b>		68B40747
600	ZX-6RR	03>04	••		<b>78B40815</b>		68B40747
600	ZX-6RR	05>06	••		<b>78B40840</b>		68B40747
600	ZX-6R	07>09	••		<b>78B40840</b>		68B40747
600	ZZR	90>92	••		<b>78B40841</b>		
600	ZZR	93>04	••		<b>78B40841</b>		68B40779
636	ZX6R 636 NINJA	02	••		<b>78B40841</b>		68B40747
636	ZX6R 636 NINJA	03>04	••		<b>78B40815</b>		68B40747
636	ZX-6R 636 NINJA	05>06	••		<b>78B40840</b>		68B40747
636	ZX 6 RR	03>06	••				68B40747
650	ER 6 F	06>08	••		<b>78B40840</b>		68B40747
650	ER 6 F ABS	06>08	••				68B40747
650	ER 6 N	06>10	••		<b>78B40840</b>		68B40747
650	ER 6 N ABS	06>10	••				68B40747
650	KLX-R	96>	•				68B40746
650	VERSYS	07>08	••		<b>78B40840</b>		68B40747
650	VERSYS ABS	07>08	••				68B40747



Genuine

Serie Oro

Genuine

Serie Oro

**KAWASAKI**

750	GPX R	86>90	••				68B40779
750	Z 750	04>06	••		<b>78B40841</b>		68B40747
750	Z 750	07>10	••		<b>78B40840</b>		68B407A3
750	Z 750 S	05>06	••		<b>78B40841</b>		68B40747
750	ZEPHIR	91>03	••		<b>78B40841</b>		
750	ZR7/S	99>	••		<b>78B40841</b>		68B40779
750	ZX-7R	96>02	••				68B40761
750	ZX 7 R NINJA	99>03	••				68B40761
750	ZX-7RR	96>	••				68B40761
900	GPZ R	90>03	••		<b>78B40841</b>		68B407F2
900	ZX-9R	98>99	••				68B40747
900	ZX-9R	00>01	••				68B40747
900	ZX-9R	02>03	••				68B40747
1000	GTR	94>06	••		<b>78B40841</b>		68B40761
1000	KLV	04>07	••		<b>78B40865</b>		
1000	Z1000	03>06	••		<b>78B40841</b>		68B40747
1000	Z1000	07>	••		<b>78B40840</b>		68B407A3
1000	Z1000/ABS	07>09	••		<b>78B40840</b>		68B407A3
1000	ZX 10 R	04>07	••		<b>78B40840</b>		68B40747
1000	ZX10R NINJA	08>	••		<b>78B40861</b>		68B40747
1100	GPZ	95>98	••		<b>78B40841</b>		
1200	ZX12R NINJA	04>06	••		<b>78B40841</b>		
1400	GTR	07>	••		<b>78B40861</b>		68B407A3
1400	ZZR	06>	••		<b>78B40861</b>		68B407A3

**KEEWAY**

125	OUTLOOK	08>	•			68B40740	68B40740
151	OUTLOOK	08>	•			68B40740	68B40740

**KL**

50	BOMBER	94	•			68B40710	
50	HELIOS	98>	•	108489930		68B40717	
50	INVADER	98>	•			68B40710	
50	KRX	98>	•			68B40710	
50	KRYPTON	99>	•	108489930		68B40717	
50	RACER	94	•			68B40710	
50	XR7	98>	•	108489930		68B40717	
125	NOX	00	•	108489930		68B40717	
125	PROXY	01>	•	108489930		68B40717	
125	PULSAR	00	•	108489930		68B40717	
150	NOX	00	•	108489930		68B40717	

**KL**

150	PROXY	01>	•	108489930		68B40717	
150	PULSAR	00	•	108489930		68B40717	

**KTM**

125	EXC	98>10	•			68B407B8	68B40752
125	GS	88>92	•				68B40752
125	GS	93>97	•			68B407B8	68B40752
125	MX	89>92	•			68B407B8	68B40752
125	STING	98>	•				68B40752
125	SX	93>	•			68B407B8	68B40752
125	SXS	00>	•			68B407B8	68B40752
144	SX	07>	•			68B407B8	68B40752
200	EXC	98>	•			68B407B8	68B40752
200	MXC	98>03	•			68B407B8	68B40752
200	SX	03>09	•			68B407B8	68B40752

**KTM**

200	XC W	06>09	•			68B407B8	68B40752
250	EXC	98>	•			68B407B8	68B40752
250	EXC-F	03	•			68B407B8	
250	EXC-F	04>	•			68B407B8	68B40752
250	GS	88>92	•				68B40752
250	GS	93>97	•			68B407B8	68B40752
250	MX	89>91	•				68B40752
250	MX	92	•			68B407B8	68B40752
250	MXC	98>03	•			68B407B8	68B40752
250	SX	93	•			68B407B8	68B40752
250	SX	98>	•			68B407B8	68B40752
250	SX-F	03>	•			68B407B8	68B40752





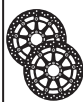

Genuine

Serie Oro

Genuine

Serie Oro

**KTM**

250	SXS	03>	•		68B407B8		68B40752
250	SXS-F	03>	•		68B407B8		68B40752
250	XC-F	07>09	•		68B407B8		68B40752
250	XC-W	06>09	•		68B407B8		68B40752
300	EXC	97>	•		68B407B8		68B40752
300	GS	91>96	•		68B407B8		68B40752
300	MX	91>92	•		68B407B8		68B40752
300	MXC	98>05	•		68B407B8		68B40752
300	SX	93	•		68B407B8		68B40752
300	SX	97>03	•		68B407B8		68B40752
300	XC	06>09	•		68B407B8		68B40752
300	XC-W	06>09	•		68B407B8		68B40752
350	GS 4T	93>	•		68B407B8		68B40752
380	EXC 2T	98>02	•		68B407B8		68B40752
380	SX	98>02	•		68B407B8		68B40752
380	MXC	98>01	•		68B407B8		68B40752
400	EGS	96>99	•		68B407B8		68B40752
400	EXC	94>06	•		68B407B8		68B40752
400	EXC	10	•		68B407B8		68B40752
400	SX	00>02	•		68B407B8		68B40752
400	XC-W	07>09	•		68B407B8		68B40752
450	EXC	03>	•		68B407B8		68B40752
450	MXC	03>06	•		68B407B8		68B40752
450	SMR	04>08	•				68B40752
450	SX F	03>07	•		68B407B8		68B40752
450	SXS	03>	•		68B407B8		68B40752
450	SXS-F	03>	•		68B407B8		68B40752
450	XC	06>09	•		68B407B8		68B40752
450	XC-F	07>09	•		68B407B8		68B40752
450	XC-W	07>09	•		68B407B8		68B40752
500	MX	89>93	•		68B407B8		68B40752
500	SX	93>95	•		68B407B8		68B40752
505	SX-F	07>09	•		68B407B8		68B40752
505	XC-F	07>09	•		68B407B8		68B40752
520	EXC	00>02	•		68B407B8		68B40752
520	MXC	01>02	•		68B407B8		68B40752
520	SX RACING	00>02	•		68B407B8		68B40752
525	EXC	03>08	•		68B407B8		68B40752
525	MXC	03>05	•		68B407B8		68B40752
525	SMR	04>05	•				68B40752
525	SX	03>06	•		68B407B8		68B40752
525	XC W	06>08	•		68B407B8		68B40752
525	XC G	06>08	•		68B407B8		68B40752
530	EXC	08>	•		68B407B8		68B40752
540	SXC	98>00	•		68B407B8		68B40752
540	SXS	01>06	•		68B407B8		68B40752
560	SMR	06>08	•				68B40752
600	GS 4T	93>	•		68B407B8		68B40752
600	LC4	90>93	•		68B407B8		68B40752
600	MX	90>92	•		68B407B8		68B40752
620	ADVENTURE	97>98	•				68B40752
620	DUKE 4T	95>	•				68B40752
620	DUKE 4T	98>	•				68B40752
620	EGS-LC4	96>02	•				68B40752
620	LC4 SC SUPERCOMPETITION	98>04	•		68B407B8		68B40752
620	LC4 SXC SUPERMOTO	99>01	•		68B407B8		68B40752
625	LC4 SC SUPERCOMPETITION	02	•		68B407B8		68B40752
625	LC4 SC SUPERCOMPETITION	03>04	•				68B40752
625	SMC	05>08	•	108200370	<b>78B40870</b>		68B40752
625	SXC	03>08	•		68B407B8		68B40752
640	DUKE II	99>02	•				68B40752
640	DUKE II	03>06	•	108200370	<b>78B40870</b>		68B40752
640	LC4 ADVENTURE	98>07	•				68B40752
640	LC4 ENDURO	98>07	•				68B40752
640	LC4 SUPERMOTO	98>04	•				68B40752
640	LC4 SUPERMOTO	05	•	108200370	<b>78B40870</b>		68B40752
640	LC4 SUPERMOTO	06>	•				68B40752

1

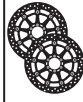

Genuine

Serie Oro

Genuine

Serie Oro

KTM							
660	SMC	03>07	•				68B40752
690	DUKE	08>	•		<b>78B40870</b>		68B407F0
690	SM	07>	•		<b>78B40870</b>		68B407F0
690	SM R	08>	•				68B407F0
950	ADVENTURE/S	03>	•				68B407F0
950	SUPERENDURO R	06>08	•				68B407F0
950	SUPERMOTO	05>07	••				68B407F1
990	ADVENTURE S/ABS	06>07	••				68B407F0
990	SUPERDUKE	05>	••	108200372	<b>78B40870</b>		68B407F1
990	SUPERMOTO	07>08	••				68B407F1

KYMCO							
50	AGILITY R 10"	06>	•		68B40714		
50	AGILITY R 12"	06>	•		68B40714		
50	AGILITY R 16"	08>	•		68B407B2		
50	B&W	01>02	•		68B40730		
50	B&W	03>	•		68B40731		
50	DINK	98>02	•		68B40714		
50	DINK	03>07	•		68B40731		
50	DINK	08>	•		68B40771		
50	FEVER ZX	99>	•		68B40714		
50	MXER	02>03	•				68B40714
50	PEOPLE	99>02	•		68B40757		
50	PEOPLE S	05>	•		68B407B2		
50	SUPER 9	02>	•				68B40714
50	TOP BOY	99>	•		68B40714		
50	YUP SP	00>	•		68B40714		
50	VITALITY	08>	•		68B40714		
90	YUP SP	95>	•		68B40714		
125	AGILITY R 12"	06>08	•		68B40714		
125	AGILITY R 16"	08>	•		68B407B2		68B40795
125	B & W	00>	•		68B40730		68B40714
125	DINK	98>	•		68B40714		68B40714
125	DINK LX	99>01	•		68B40714		68B40714
125	DINK CLASSIC	02>	•		68B40731		68B40714
125	GRAN DINK	02>	•		68B40731		68B40724
125	MXER	02>03	•				68B40714
125	MOVIE XL	99>	•		68B40731		
125	PEOPLE	99>	•		68B40757		
125	PEOPLE S	05>06	•		68B407B2		
125	PEOPLE S	07>	•		68B407B2		68B407B2
150	AGILITY R 16"	08>	•		68B407B2		68B40795
150	B&W	00>	•		68B40730		68B40714
150	DINK	98>01	•		68B40714		68B40714
150	DINK CLASSIC	02>	•		68B40731		
150	DINK LX	98>01	•		68B40714		68B40714
150	GRAND DINK	02>	•		68B40731		68B40724
150	MXER	02>03	•				68B40714
150	MOVIE XL	01>	•		68B40731		
150	PEOPLE	99>	•		68B40757		
200	DINK CLASSIC	03>	•		68B40731		68B40714
200	PEOPLE S	05>06	•		68B407B2		
200	PEOPLE S	07>	•		68B407B2		68B407B2
250	B & W	00>	•		68B40731		68B40714
250	GRAN DINK	00>	•		68B40731		68B40724
250	PEOPLE S	02>05	•		68B407B2		68B407B2
250	PEOPLE S	06>	••		68B407B2		68B407B2
250	XCITING	05>	••		68B407E1		68B40799
250	YUP	03>	•		68B40731		68B40724
250	XCITING	05>	•		68B407E1		68B40799
300	PEOPLE S	08>	••		68B407B2		68B407B2
300	MXU	06>	••				68B40714
300	XCITING/R	08>	••		68B407E1		68B40799
500	XCITING	04>	••		68B407E1		68B40799
500	XCITING R	07>	••		68B407E1		68B40799

LAVERDA							
650	GHOST	96>99	••	108489982	<b>78B40870</b>		68B40791
650	SPORT	95>01	••	108489982	<b>78B40870</b>		68B40791



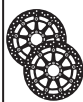

Genuine

Serie Oro

Genuine

Serie Oro

**LAVERDA**

668	DIAMANTE	96>98	••	108489982	<b>78B40870</b>		68B40791
668	STRIKE	97>99	••	108489982	<b>78B40870</b>		68B40791
750	BLACK STRIKE	00>	••	108489982	<b>78B40870</b>		68B40791
750	FORMULA	97>98	••	108489982	<b>78B40870</b>		68B40791
750	FORMULA	99>01	••				68B40791
750	SPORT	97>98	••	108489982	<b>78B40870</b>		68B40791
750	STRIKE	98>01	••				68B40791
750	SUPER SPORT	99>00	••				68B40791
800	T-8	98	••	108489982	<b>78B40870</b>		68B40791
800	TSS	98	••	108489982	<b>78B40870</b>		68B40791
1000	SFC LIMITED EDITION	03>	••			108489925	

**LEM**

50	FLASH	93	•		68B40710		
----	-------	----	---	--	----------	--	--

**LML ITALIA**

150	STAR DE LUXE	09>	•		68B40722		
-----	--------------	-----	---	--	----------	--	--

**MALAGUTI**

50	CIAK ELECTRONIC POWER	00>01	•		68B40721		
50	CIAK TD	00>01	•				68B40715
50	CENTRO SL	93>07	•		68B40723		
50	CIAK	99>01	•		68B40715		
50	CROSSER	95>98	•		68B40715		
50	CROSSEREL	97>	•		68B40715		
50	DRAKON	05>06	•				68B40722
50	F12 PHANTOM	94>98	•		68B40715		
50	F12 PHANTOM DIGIT	00>02	•		68B40715		68B40715
50	F12 PHANTOM DIGIT (ALL)	03>	•		68B40721		68B40715
50	F12 PHANTOM AIR C. REST. E.2	06	•		68B40721		
50	F12 PHANTOM CAPIREX	03>	•		68B40721		68B40715
50	F12 PHANTOM E.1	99>00	•		68B40721		
50	F12 PHANTOM FOGGY	00>	•		68B40721		68B40715
50	F12 PHANTOM LC	94>98	•		68B40715		
50	F12 PHANTOM LC E.1	99>00	•		68B40721		68B40715
50	F12 PHANTOM LC REST. E.1	01>02	•		68B40721		68B40715
50	F12 PHANTOM LC REST. E.2	02>06	•		68B40721		68B40715
50	F12 PHANTOM LC REST. E.3	03>04	•		68B40721		68B40715
50	F12 PHANTOM LC TWIN DISKS	98>00	•		68B40715		68B40715
50	F12 PHANTOM REST. E.1	01>02	•		68B40721		
50	F12 PHANTOM REST. E.2	02	•		68B40721		
50	F12 PHANTOM REST. E.3	03>04	•		68B40721		
50	F12 PHANTOM SPECTRUM	00>	•		68B40721		68B40715
50	F15 FIRE FOX	96>98	•		68B40715		
50	F15 FIRE FOX AIR COOLED	05>06	•		68B40721		
50	F15 FIRE FOX E.2	02>03	•		68B40721		68B40715
50	F15 FIRE FOX FUN	99>00	•		68B40721		68B40715
50	F15 FIRE FOX LC	96>98	•		68B40715		
50	F15 FIRE FOX LC-TDS REST. E.1	99>01	•		68B40721		68B40715
50	F15 FIRE FOX LC REST. E.2	04>05	•		68B40721		68B40715
50	F15 FIRE FOX REST. E.2	03>04	•		68B40721		68B40715
50	F15 FIRE FOX FUN	03>	•		68B40721		68B40715
50	F15 FIRE FOX TWIN DISK DIGIT KAT	98>00	•		68B40721		68B40715
50	F15 FIRE FOX TWIN DISK & SPECIAL	98>99	•		68B40715		68B40715
50	SILVERFOX	96>	•		68B40715		
100	CIAK	99>	•		68B40715		68B40715
100	F12 PHANTOM	99>	•		68B40721		68B40715
125	CENTRO IE	08>	•		68B407A9		68B40766
125	F18 PROJECT	00>	•				68B40735
125	F18 WARRIOR	00>	•				68B40735
125	MADISON	99>	•		68B40735		68B40735
125	MADISON BLACK RIDER	03>	•		68B40735		68B40735
125	PHANTOM MAX	03>	•		68B40735		68B40735
150	F 18 PROJECT	00>	•				68B40735
150	F 18 WARRIOR	00>	•				68B40735
150	MADISON	99>	•		68B40735		68B40735
160	CENTRO IE	07>	•		68B407A9		68B40766
180	MADISON	99>	•		68B40735		68B40735
200	MADISON	02>	•		68B40735		68B40735
200	MADISON BLACK RIDER	03>	•		68B40735		

1



Genuine

Serie Oro

Genuine

Serie Oro

**MALAGUTI**

200	PHANTOM MAX	03>	•		68B40735		68B40735
250	MADISON	99>03	•		68B40772		68B40735
250	MADISON RS	04>	•		68B40735		68B40735
250	PASSWORD CK 250	05>	•		68B407E5		68B40798
250	PHANTOM MAX	05>06	•		68B40735		68B40735
400	MADISON	02>	•		68B407E5		68B40772
500	SPYDER MAX GT	04>	••		68B407E5		68B407E2
500	SPYDER MAX RS	09>	••		68B407E5		68B407E2

**MBK**

50	BOOSTER ALL MODEL	96>99	•		68B40710		
50	BOOSTER N.G.	01>04	•	108200010	68B40716		
50	BOOSTER R	93>95	•		68B40710		
50	EVOLIS	92>	•		68B40710		
50	F1 ASSISTANCE	01	•	108200010	68B40716		
50	FIZZ	94>	•		68B40710		
50	FORTE	94>	•		68B40710		
50	NEOS	94>	•	108489930	68B40717		
50	NITRO	97>	•	108200010	68B40716	108200010	68B40716
50	OVETTO	96	•	108489930	68B40717		
50	SLIDER	>	•	108200010	68B40716		
50	STUNT	00>	•	108200010	68B40716		
50	TARGET	92>94	•		68B40710		
50	TRACK	95>	•		68B40710		
80	EVOLIS	94>	•		68B40710		
100	NITRO	00>	•	108200010	68B40716	108200010	68B40716
100	OVETTO	00>	•	108489930	68B40717		
125	DOODO	00>	•	108489926			
125	SKYLINER	99>01	•	108489926			
125	SKYLINER	02>	•	108489926		108200011	
125	THUNDER	01	•	108200046		108489923	
150	DOODO	01>	•	108489926			
150	SKYLINER	00	•	108489926			
150	SKYLINER	01>	•	108489926		108200011	
180	SKYLINER	03>	•	108489926			
250	SKYLINER	00>	•		68B40791		68B40765
300	KILIBRE	03>	•		68B407C5		68B40778

**MONDIAL**

50	MKX1	99>	•		68B40710		
50	MKX3	99>	•		68B40710		
50	XR7	99>	•	108489930	68B40717		
999	PIEGA	03>	••	108200370	<b>78B40870</b>	108489923	
999	PIEGA EVO	03>	••	108200370	<b>78B40870</b>	108489923	
999	PIEGA NUDA	04>	••	108200370	<b>78B40870</b>	108489923	
999	RZ NUDA	02>	••			108489923	
999	RZ STARFIGHTER	02>	••			108489923	

**MOTO GUZZI**

750	BREVA	03>07	•	108489993	<b>78B40870</b>		
750	NEVADA	03>07	•	108489993	<b>78B40870</b>		
750	NEVADA CLASSIC I.E.	03>	•	108489993	<b>78B40870</b>		

**MOTO GUZZI**

750	NEVADA CLUB	03>	•	108489993	<b>78B40870</b>		
850	BREVA	06>08	••		<b>78B40870</b>		
850	GRISO	06	••		<b>78B40870</b>		
850	NORGE T-GTL	07>	••		<b>78B40870</b>	108489948	
850	NORGE T-GTL ABS	07>	••	108200385	<b>78B40870</b>		
1000	DAYTONA RACING	96	••	108489982	<b>78B40870</b>		
1000	DAYTONA RS	96>	••	108489982	<b>78B40870</b>	108489943	
1000	V 10 CENTAURO	97>99	••	108489982	<b>78B40870</b>	108489948	
1000	V 10 CENTAURO GT	99>00	••	108489982	<b>78B40870</b>	108489948	
1000	V 10 CENTAURO SPORT	98>00	••	108489982	<b>78B40870</b>	108489948	
1100	BREVA	05>07	••	108200384	<b>78B40870</b>	108489948	
1100	BREVA ABS	05>07	••	108200385	<b>78B40870</b>		
1100	CALIFORNIA ALUMINIUM	03>	••	108489982	<b>78B40870</b>	108489943	
1100	CALIFORNIA EV	97>02	•	108489982	<b>78B40870</b>	108489943	
1100	CALIFORNIA EV/TOURING	03>	••	108489993	<b>78B40870</b>	108489943	
1100	CALIFORNIA JACKAL	99>01	••	108489982	<b>78B40870</b>	108489943	
1100	CALIFORNIA SPECIAL	99>00	••	108489982	<b>78B40870</b>	108489943	



				Genuine	Serie Oro	Genuine	Serie Oro
--	--	--	--	---------	-----------	---------	-----------

### MOTO GUZZI

1100	CALIFORNIA TITANIUM	03>	••	108489982	<b>78B40870</b>	108489943	
1100	GRISO	05>08	••	108200384	<b>78B40870</b>	108489948	
1100	METAL	02>	••	108489993	<b>78B40870</b>	108489943	
1100	SPORT	94>96	••	108489982	<b>78B40870</b>		
1100	SPORT	98>99	••	108200384	<b>78B40870</b>	108489948	
1100	SPORT	00>	••	108489993	<b>78B40870</b>	108489943	
1100	SPORT I.E.	96>99	••	108489982	<b>78B40870</b>	108489948	
1100	STONE	01>02	••	108489982	<b>78B40870</b>	108489943	
1100	STONE	03>	••	108489993	<b>78B40870</b>	108489943	
1100	V 11	00	••	108489982	<b>78B40870</b>	108489943	
1100	V 11 BALLABIO	03>	••	108489993	<b>78B40870</b>	108489943	
1100	V 11 CAFE' SPORT	03>	••	108489993	<b>78B40870</b>	108489943	
1100	V 11 COPPA ITALIA	03>	••	108489993	<b>78B40870</b>	108489943	
1100	V 11 LE MANS	01>	••	108489993	<b>78B40870</b>	108489943	
1100	V 11 LE MANS NERO CORSA	03>	••	108489993	<b>78B40870</b>	108489943	
1100	V 11 LE MANS ROSSO CORSA	03>	••	108489993	<b>78B40870</b>	108489943	
1100	V 11 NAKED	01>02	••	108489993	<b>78B40870</b>	108489943	
1100	V 11 NAKED	03>	••			108489943	
1100	V 11 SPORT	01>02	••	108489993	<b>78B40870</b>	108489943	
1200	BREVA	08>09	••		<b>78B40870</b>		
1200	BREVA ABS	08>09	••	108200385	<b>78B40870</b>		
1200	GRISO 8V	07>08	••		<b>78B40870</b>		
1200	NORGE ABS	06>	••	108200385	<b>78B40870</b>		
1200	NORGE T-GTL	06>	••		<b>78B40870</b>		
1200	SPORT	06>07	••		<b>78B40870</b>		
1200	SPORT 8V	09	••		<b>78B40870</b>		
1200	SPORT ABS	06>07	••	108200385	<b>78B40870</b>		
1200	STELVIO (RAD. CAL.)	08>09	••		<b>78B40870</b>		

### MOTO MORINI

998	9 1/2	06>09	••	108200370	<b>78B40870</b>		
1200	CORSARO	05>09	••	108200370	<b>78B40870</b>		

### MOTOR UNION

125	MAXI	99>	•		68B40791		68B40714
150	MAXI	99>	•		68B40791		68B40714
150	MIDI	99>	•		68B40714		68B40714
400	MAXI	99>	•		68B40791		68B40714

### MOTRON

50	SPIKE-S	98>	•		68B40716		
50	SYNCR0	99>	•		68B40716		
50	ZR THUNDER	95>	•		68B40716		

### MV

750	BRUTALE S	01>06	••		<b>78B40868</b>		
750	F4 BIPOSTO-S	00>06	••		<b>78B40868</b>		
750	F4 SENNA	98>06	••		<b>78B40868</b>		
910	BRUTALE S	06	••		<b>78B40868</b>		
910	BRUTALE R	06>08	••	108200366			
1000	F4 S MAMBA	04>07	••		<b>78B40868</b>		
1000	F4R TAMBURINI	06>08	••	108200366			
1000	F4RR 312 RR	07>08	••	108200366			
1078	F4	09>	••	108200366			
1078	BRUTALE RR	09>	••	108200366			

### MZ

1000	1000 S	01>02	••		<b>78B40870</b>		
1000	1000 S	03>	••		<b>78B40870</b>		

### PEUGEOT

50	BLASTER	09>	•		68B40716		
50	BUXY R	93>97	•		68B40716		
50	BUXY RS	93>97	•		68B40716		
50	ELYSEO	97>	•		68B40716		
50	ELYSEO (PINZA AJP)	99>	•		68B40716		
50	ELYSTAR	01>	•		68B40758		68B40716
50	JET FORCE/C-TECH	03>	•		68B40758		68B40716
50	LOOXOR	02>	•				68B40716
50	LUDIX CLASSIC/ELEGANCE	03>	•		68B40716		
50	LUDIX SNAKE/TREND	03>	•		68B40710		
50	METAL X	01>	•		68B40716		
50	SPEEDAKE	94>97	•		68B40716		

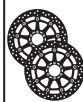
**Genuine****Serie Oro****Genuine****Serie Oro****PEUGEOT**

50	SPEED FIGHT (PINZA BREMBO)	96>	•				68B40714
50	SPEEDFIGHT (PINZA AJP)	00>	•				68B40714
50	SQUAB	94>	•		68B40716		
50	SQUAB (PINZA AJP)	96>	•		68B40716		
50	SV GEO	91	•		68B40716		
50	SV GEO	92	•		68B40716		
50	SV GEO EXECUTIVE	96	•		68B40716		
50	SV ROLAND GARROS	93>	•		68B40716		
50	SVM	97	•		68B40710		
50	TKR	96>	•		68B40716		
50	TKR STREET ZONE	03>	•		68B40715		
50	TREEKKER	99>	•		68B40716		
50	TREEKKER STREETBOARD	00>	•		68B40716		
50	TREKKER URBAN BLACK	00>	•		68B40716		
50	V-CLIC	09>	•		68B40710		
50	VIVACITY	99>07	•		68B40716		
50	VIVACITY 4T	08>	•		68B40721		
50	VIVACITY COMPACT	03>	•		68B40716		
50	VIVACITY XRACE	03>	•		68B40716		
50	X-RACE	02>05	•				68B40714
80	SV	91>	•		68B40716		
100	ELYSEO	96>	•		68B40758		
100	ELYSEO	00>	•		68B40758		
100	ELYSEO (PINZA AJP)	98>99	•		68B40758		
100	LOOXOR	02>	•				68B40716
100	SPEEDFIGHT(PINZAAJP)	98>02	•				68B40714
100	SV	98>99	•		68B40716		
100	TREKKER	99>	•		68B40716		
100	VIVACITY	99>07	•		68B40716		
125	ELYSEO	00>	•		68B40758		
125	ELYSEO	98>99	•		68B40758		
125	ELYSTAR	01>	•		68B40758		
125	EXECUTIVE	94>	•		68B40716		
125	GEO RS	08>	•		68B407D9		
125	JET FORCE	03>	•		68B40758		
125	LOOXOR	02>	•				68B40716
125	SATELIS ABS	06>08	•		68B407D9		68B407A8
125	SV GEO	91>	•		68B40716		
150	ELYSEO	00>	•		68B40758		
150	ELYSTAR	01>	•		68B40758		68B40716
150	LOOXOR	02>	•				68B40716
250	GEOPOLIS	06>	•		68B407D9		68B407A8
250	GEO RS	08>	•		68B407D9		
250	SV	02>	•		68B40775		68B40749
400	GEOPOLIS	07>	•		68B407D9		68B407A8
400	GEO RS	08>	•		68B407D9		
400	SATELIS	07>	••				68B407A8
400	SAT RS	07>	•				68B407A8
500	GEOPOLIS	08>	•		68B407D9		
500	SATELIS	06>	••				68B407A8
500	SAT RS	07>	•				68B407A8

**PGO**

50	BIG MAX	94>02	•		68B40710		
50	BIG MAX SPORT	96>	•		68B40710		
50	MEGA FIFTY	99>	•		68B40710		
50	MOT	97>	•		68B40710		
50	PMX	97>	•		68B40710		
50	TORNADO	96>02	•		68B40710		
80	BIG MAX	95>	•		68B40710		
90	BIG MAX	97>00	•		68B40710		

**PIAGGIO**

50	CLASSIC SPORT	97>	•		68B40730		
50	FLY 2T	05>10	•		68B40722		
50	FLY 4T	05>10	•		68B40722		
50	FREE FL	95>02	•		68B40722		
50	LIBERTY	97>05	•		68B40738		
50	LIBERTY 2T	06>08	•		68B40738		



**Genuine****Serie Oro****Genuine****Serie Oro****PIAGGIO**

50	LIBERTY 2T RST	04	•		68B40738		
50	LIBERTY 2T SPORT	06>08	•		68B40738		
50	LIBERTY 4T	00>08	•		68B40738		
50	LIBERTY 4T RST	04	•		68B40738		
50	LIBERTY 4T DELIVERY TNT	09	•		68B40738		
50	LIBERTY 4T SPORT	06>08	•		68B40738		
50	LIBERTY PTT E.2	04>05	•		68B40738		
50	NRG EXTREME	99>00	•		68B40730		68B40713
50	NRG MC3	01>04	•		68B40730		68B40713
50	NRG POWER DD	05>10	•		68B40738		68B40713
50	NRG POWER DD SERIE SPECIALE	07>08	•		68B40738		68B40713
50	NRG POWER DT	06>08	•		68B40738		
50	NRG POWER PUREJET	04>09	•		68B40738		68B40713
50	NRG PUREJET	02>04	•		68B40730		68B40713
50	NRG PUREJET	10	•		68B40738		68B40713
50	NRG RST MC2	96>98	•		68B40717		68B40713
50	NTT	96	•	108489930	68B40717		
50	QUARTZ	95	•		68B40723		
50	SFERA RST	96>98	•		68B40722		
50	SKIPPER	92>	•		68B40723		
50	STALKER	97>99	•				68B40713
50	STEALTH	98	•		68B40730		
50	STORM	94>	•	108489930	68B40717		
50	TYPHOON	94>	•	108489930	68B40717		
50	VESPA ET2/ET4	97>05	•		68B40722		
50	VESPA LX 2T	05>08	•		68B40722		
50	VESPA LX 2T FL	09>10	•		68B40722		
50	VESPA LX 2T TOURING	10	•		68B40722		
50	VESPA LXV 2T NAVY	08	•		68B40722		
50	VESPA LX 4T-4V	09>10	•		68B40722		
50	VESPA LX 4T-4V TOURING	10	•		68B40722		
50	VESPA S 2T & COLLEGE	07>10	•		68B40722		
50	VESPA S 4T-4V	08>09	•		68B40722		
50	ZIP DISCO	96>	•		68B40710		
50	ZIP	00>04	•		68B40713		
50	ZIP 2T	08>10	•		68B40713		
50	ZIP 4T	00>10	•		68B40713		
50	ZIP FAST RIDER	93>00	•		68B40710		
50	ZIP SP	96>08	•		68B40722		
50	ZIP SP E.2	06>09	•		68B40722		
50	ZIP SPORT H2O-SP	96>	•		68B40722		
50	ZIP SPORT RST	95>	•		68B40710		
50	ZIP II	01>	•		68B40713		
75	SFERA	96>97	•		68B40722		
80	SKIPPER	96	•		68B40723		
80	TYPHOON	96>	•	108489930	68B40717		
100	FLY 4T	08	•		68B40722		
100	FREE	02>03	•		68B40738		
100	ZIP 4T	06>08	•		68B40713		
125	BEVERLY	01>03	•		68B407B7		68B407B7
125	BEVERLY E.3 MIC	07	•		68B407B7		68B407B7
125	BEVERLY E.3 SPORT	07>08	•		68B407B7		68B407B7
125	BEVERLY E.3	07>08	•		68B407B7		68B407B7
125	BEVERLY RST	04>07	•		68B407B7		68B407B7
125	BEVERLY TOURER E.3	08>10	•		68B407B7		68B407B7
125	CARNABY	07>10	•		68B407B7		68B407B7
125	COMMUTER	93>	•		68B40723		
125	HEXAGON	94>97	•		68B40712		
125	HEXAGON GTX	00>	•		68B40722		68B40722
125	HEXAGON LX	98>99	•		68B40722		
125	FLY	05>07	•		68B40722		
125	FLY E.3	07>08	•		68B40722		
125	LIBERTY	98>02	•		68B40738		
125	LIBERTY RST	04>05	•		68B40738		
125	LIBERTY RST PTT	05>06	•		68B40738		
125	LIBERTY SPORT	06	•		68B40738		
125	LIBERTY 4T	06>07	•		68B40738		

1

**Genuine****Serie Oro****Genuine****Serie Oro****PIAGGIO**

125	LIBERTY 4T DELIVERY E.3	08	•		68B40738		
125	LIBERTY 4T E.3	07>08	•		68B40738		
125	LIBERTY 4T SPORT E.3	06>08	•		68B40738		
125	MP3	07>08	••		68B40774		68B40777
125	MP3 IE	08>09	••		68B40774		68B40777
125	MP3 HYBRID	09>10	••		68B40774		68B40777
125	QUARZT	92>	•		68B40723		
125	SFERA	96>98	•		68B40722		
125	SKIPPER	93>95	•		68B40723		
125	SKIPPER 4T	00>02	•		68B40730		
125	SKIPPER LX	98>99	•		68B40730		
125	SKR	01>02	•		68B40730		
125	STEALTH	96>	•		68B40730		
125	SUPER HEXAGON GTX 12"	01>02	•		68B40777		68B40738
125	TYPHOON	96>	•	108489930	68B40717		
125	TYPHOON CATALIZZATO	02>	•	108489930	68B40717		
125	VESPA ET4	96>02	•		68B40722		
125	VESPA GRANTURISMO L	01>03	•		68B40730		68B40730
125	VESPA GRANTURISMO	03>07	•		68B40738		68B40738
125	VESPA GRANTURISMO E.3	06>07	•		68B40738		68B40738
125	VESPA GT L	04	•		68B40738		68B40738
125	VESPA GTV	07>08	•		68B40738		68B40738
125	VESPA GTV 4T NAVY E.3	08	•		68B40738		68B40738
125	VESPA GTS 4T IE SUPER	09	•		68B40738		68B40738
125	VESPA GTS E.3	07>09	•		68B40738		68B40738
125	VESPA LX	04>	•		68B40722		
125	VESPA LX 4T FL	09	•		68B40722		
125	VESPA LX E.3 IE	09>10	•		68B40722		
125	VESPA LX TOURING	10	•		68B40722		
125	VESPA LXV 4T NAVY E.3	08	•		68B40722		
125	VESPA LXV IE 4T	10	•		68B40722		
125	VESPA PX	96>08	•		68B40722		
125	VESPA PX	98>01	•		68B40722		
125	VESPA PX 30 ANNI	07>08	•		68B40722		
125	VESPA S 4T E.3	07>08	•		68B40722		
125	VESPA S 4T IE & COLLEGE	09>10	•		68B40722		
125	ZIP	00>02	•		68B40713		
125	ZIP 4T	02>	•		68B40738		
125	X EVO	07	•		68B407B6		68B40777
125	X 7	07>	•		68B407B6		68B40776
125	X7 E.3	09	•		68B407B6		68B40777
125	X7 EVO IE E.3	09>10	•		68B407B6		68B40777
125	X8 PREMIUM E.2	06	•		68B407B6		68B40777
125	X8 PREMIUM E.3	06>07	•		68B407B6		68B40777
125	X8	04>06	•		68B407B6		68B40777
125	X9 EVOLUTION	03	••		68B40776		68B40776
125	X9 EVOLUTION E.3	07	••		68B40776		68B40776
125	X9	01>02	••		68B40776		68B40776
150	COMMUTER	93>	•		68B40723		
150	FLY	05>07	•		68B40722		
150	FLY E.3	08>10	•		68B40722		
150	HEXAGON	94>97	•		68B40712		
150	HEXAGON	98>	•		68B40722		68B40776
150	LIBERTY	00>	•		68B40738		
150	LIBERTY 4T E.3	08	•		68B40738		
150	LIBERTY 4T SPORT E.3	08	•		68B40738		
150	QUARZT	92>	•		68B40723		
150	SKIPPER	94>97	•		68B40723		
150	SKIPPER LXT - ST	99>	•		68B40730		
150	SKR	01>02	•		68B40730		
150	STEALTH	96>	•		68B40730		
150	SUPERHEXAGON	99>	•		68B40738		68B40738
150	VESPA ET4	99	•		68B40722		
150	VESPA GRANTURISMO L	01>	•		68B40730		68B40730
150	VESPA LX E.3 IE	09>10	•		68B40722		
150	VESPA LX 4T FL	09	•		68B40722		
150	VESPA LX TOURING	10	•		68B40722		



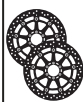

**Genuine****Serie Oro****Genuine****Serie Oro****PIAGGIO**

150	VESPA PX	02>	•		68B40722		
150	VESPA S 4T	08>09	•		68B40722		
150	VESPA S 4T IE & COLLEGE	09>10	•		68B40722		
180	HEXAGON	94>98	•		68B40712		
180	HEXAGON	99>	•		68B40722		
180	SUPERHEXAGON	99>00	•		68B40722		68B40722
180	SUPER HEXAGON GTX 12"	01>02	•		68B40777		68B40738
180	X9 AMALFI	00>03	••		68B40776		68B40776
200	BEVERLY	03>	•		68B407B6		68B407B6
200	CARNABY	07>08	•		68B407B7		68B407B7
200	LIBERTY	06	•		68B40738		
200	LIBERTY/S	01>	•		68B40738		
200	LIBERTY 4T E.3	07>08	•		68B40738		
200	LIBERTY 4T SPORT.3	06>07	•		68B40738		
200	LIBERTY RST	04	•		68B40738		
200	LIBERTY SPORT	06	•		68B40738		
200	VESPA GT L	04>	•		68B40738		68B40738
200	VESPA GRANTURISMO	06>07	•		68B40738		68B40738
200	VESPA PX/PX E	96	•		68B40722		
200	VESPA PX TIME	01	•		68B40722		
200	X8	05>07	•		68B407B6		68B40777
200	X9 EVOLUTION	03	••		68B40776		68B40776
200	X9	02>03	••		68B40776		68B40776
200	X9 AMALFI	01>	•		68B40776		68B40776
250	BEVERLY E.3 MIC	07	•		68B407B7		68B407B7
250	BEVERLY RST	04>05	•		68B407B7		68B407B7
250	BEVERLY SPORT	06>08	•		68B407B7		68B407B7
250	BEVERLY CRUISER	07>09	•		68B407B7		68B407B7
250	BEVERLY IE E.3	06>08	•		68B407B7		68B407B7
250	BEVERLY TOURER E.3	08>09	•		68B407B7		68B407B7
250	BEVERLY	06>07	•		68B407B7		68B407B7
250	CARNABY	08	•		68B407B7		68B407B7
250	HEXAGON	98>	•		68B40722		68B40738
250	MP3	06>08	••		68B40774		68B40777
250	MP3 LT	09	••		68B40774		68B40777
250	MP3 MIC	08>09	••		68B40774		68B40777
250	SUPERHEXAGON	99>01	•		68B40738		68B40722
250	VESPA GT 60 E.3	06>07	•		68B40738		68B40738
250	VESPA GTS, GTS ABS	05>10	•		68B40738		68B40738
250	VESPA GTV 4T NAVY E.3	08	•		68B40738		68B40738
250	VESPA GTV	06>09	•		68B40738		68B40738
250	X EVO	07	•		68B407B6		68B40777
250	X7 E.3	08	•		68B407B6		68B40777
250	X8 E.3	05>08	•		68B407B6		68B40777
250	X9	00>	••		68B40776		68B40776
250	X9 EVOLUTION	04	••		68B40776		68B40776
300	BEVERLY TOURER E.3	09>10	•		68B407B7		68B407B7
300	CARNABY CRUISER	09>10	•		68B407B6		68B407B7
300	MP3 IE LT	10	••		68B40774		68B40777
300	MP3 IE MIC	10	••		68B40774		68B40777
300	MP3 IE LT HYBRID	10	••		68B40774		68B40777
300	VESPA GTS SUPER	08>09	•		68B40738		68B40738
300	VESPA GTS SUPER SPORT	10	•		68B40738		68B40738
300	VESPA GTV VIA MONTENAPOLEONE	10	•		68B40738		68B40738
300	X7 EVO IE E.3	09>10	•		68B407B6		68B40777
400	BEVERLY E.3	06>07	•		68B407B6		68B40777
400	BEVERLY TOURER E.3	08>10	••		68B407B6		68B40777
400	MP3	07>08	••		68B40774		68B40777
400	MP3 LT	09	••		68B40774		68B40777
400	MP3 MIC	08>09	••		68B40774		68B40777
400	X EVO	07>09	•		68B40776		68B40777
400	X8 E.3	06>08	••		68B40776		68B40777
500	BEVERLY	02>06	••		68B407B7		68B40777
500	BEVERLY CRUISER	07>09	••		68B407B6		68B40777
500	BEVERLY E.3	06>08	••		68B407B7		68B40777
500	X9	01>02	••		68B407B7		68B40777
500	X9 EVOLUTION	03>07	••		68B407B6		68B40777

1



Genuine

Serie Oro

Genuine

Serie Oro

**PIAGGIO**

500	X9 EVOLUTION ABS	06>07	••		68B407B6		68B40777
-----	------------------	-------	----	--	----------	--	----------

**RIEJU**

50	CROSSER CR1	96>98	•		68B40716		
50	FIRST	97>99	•		68B40716		

**SIAMOTO**

50	BINGO	99	•		68B40710		
50	MAT	98>	•		68B40716		
50	TOPRACING	98>	•		68B40716		
100	MAT	99>02	•		68B40716		
100	TOP RACING	99>00	•		68B40716		
125	BINGO	99	•		68B40710		

**SUZUKI**

125	BURGMAN	01>06	•		68B40737		68B40741
125	BURGMAN NEW	06>	•		68B40770		68B40770
125	RM	89>98	•		<b>78B40813</b>		
125	RM	00>06	•		<b>78B40813</b>		68B40784
125	RM	07>08	•		<b>78B40810</b>		68B40784
125	SIXTEEN	08>	•		68B40729		68B40729
150	BURGMAN	01>06	•		68B40737		68B40741
150	SIXTEEN	08>	•		68B40729		68B40729
250	BURGMAN	98>02	•		68B407B3		68B40727
250	BURGMAN	03>06	•		68B407B4		68B40725
200	BURGMAN NEW	07>	•		68B40770		68B40770
250	RM	89>99	•		<b>78B40813</b>		
250	RM	99>08	•		<b>78B40813</b>		68B40784
250	RMZ	04>06	•		<b>78B40810</b>		68B40782
250	RMZ	07>	•		<b>78B40812</b>		68B40788
250	RM X	92>98	•		<b>78B40813</b>		
400	BURGMAN	98>02	•		68B407B3		68B40727
400	BURGMAN	03>05	•		68B407B4		68B40725
400	BURGMAN	06>09	•		68B407B4		68B40726
400	DRZ E	00>08	•		<b>78B40813</b>		
400	DRZ S	00>09	•		<b>78B40813</b>		
400	DRZ SM	05>09	•				68B40784
400	GSR	06>08	••		<b>78B40866</b>		68B40785
450	RMZ	05>	•		<b>78B40812</b>		68B40788
600	GSF BANDIT	95>99	••		<b>78B40820</b>		68B40771
600	GSF BANDIT	00>04	••		<b>78B40820</b>		68B40771
600	GSF BANDIT S	00>	••				68B40771
600	GSR	06>	••		<b>78B40866</b>		68B40785
600	GSX F	89>97	••		<b>78B40820</b>		68B407A0
600	GSX F	98>03	••		<b>78B40820</b>		68B40771
600	GSX F	04>06	••		<b>78B40821</b>		68B40771
600	GSX R	97>03	••		<b>78B40875</b>		68B40744
600	GSX R	04>05	••		<b>78B40842</b>		68B40744
600	GSX R	06>07	••		<b>78B40864</b>		68B40744
600	GSX R	08>10	••		<b>78B40863</b>		68B40744
600	RF R	93>97	••		<b>78B40820</b>		68B40771
650	BURGMAN	02>03	••		68B407B5		68B407A1
650	BURGMAN	04>09	••		68B407B4		68B407A2
650	DR R-RS	92>93	•		68B407D5		
650	DR RSE	91>95	•		68B407D5		
650	DL V-STROM	04>06	••		<b>78B40865</b>		68B407A0
650	DL V-STROM	07>	••		<b>78B40866</b>		68B407A0
650	FREEWIND	97>	•		68B407D5		
650	GLADIUS	09>	••		<b>78B40821</b>		68B40785
650	GSF BANDIT	05>06	••		<b>78B40821</b>		68B40771
650	GSF BANDIT	07>08	••		<b>78B40866</b>		68B40785
650	GSX F	08>	••		<b>78B40866</b>		68B40785
650	SV/S	99>02	••		<b>78B40820</b>		68B40771
650	SV/S	03>09	••		<b>78B40821</b>		68B40744
750	GSX F	98>03	••		<b>78B40820</b>		68B40771
750	GSX F	04>06	••		<b>78B40821</b>		68B40771
750	GSX F-FL SLINGSHOT	89>92	••		<b>78B40820</b>		68B407A0
750	GSX R	85>87	••				68B40744
750	GSX R	88>89	••				68B40744
750	GSX R	90>95	••				68B40771





				Genuine	Serie Oro	Genuine	Serie Oro
--	--	--	--	---------	-----------	---------	-----------

### SUZUKI

750	GSX-R	96>03	••		<b>78B40875</b>		68B40744
750	GSX R	04>05	••		<b>78B40842</b>		68B40744
750	GSX R	06>07	••		<b>78B40864</b>		68B40744
750	GSX R	08>10	••		<b>78B40863</b>		68B40744
800	DR BIG	91>95	•		68B407D5		
900	RF F	94>96	••				68B40771
1000	DL V-STROM	02>	••		<b>78B40865</b>		
1000	GSX R	01>02	••		<b>78B40875</b>		68B40744
1000	GSX R	03>04	••		<b>78B40842</b>		68B40744
1000	GSX R	05>08	••		<b>78B40864</b>		68B40744
1000	GSX R	09>10	••		<b>78B40863</b>		68B40744
1000	SV/S	03>07	••		<b>78B40865</b>		68B40744
1000	TL R	98>03	••		<b>78B40875</b>		68B40744
1000	TL S	97>01	••		<b>78B40875</b>		68B40744
1100	GSX-R	86>88	••				68B40744
1100	GSX-R	89	••				68B40771
1100	GSX-R	90>92	••				68B40771
1100	GSX-R W	93>00	••				68B40771
1200	GSF/S	97>02	••				68B40771
1200	GSX	99>01	••				68B40771
1200	GSX	02>	••				68B40771
1250	GSF BANDIT	06>	••		<b>78B40866</b>		68B40785
1300	B-KING	08>	••		<b>78B40866</b>		
1300	GSX-R HAYABUSA	99>07	••		<b>78B40875</b>		68B40771
1300	GSX-R HAYABUSA	08>	••		<b>78B40866</b>		
1400	GSX	02>07	••		<b>78B40875</b>		
1800	VRZ INTRUDER	06>	••		<b>78B40866</b>		

### SYM

50	CHA-CHA	99>	•		68B40711		
50	CINDERELLA	99>00	•		68B40711		
50	SUPER FANCY	99>	•		68B40711		
100	CINDERELLA	99>00	•		68B40711		
100	SUPER FANCY	95>	•		68B40711		
125	ATTILA	00>	•		68B40711		
125	HD EVO	07>	•		68B40728		
125	SUPER DUKE	00>	•		68B40711		
150	ATTILA	00>	•		68B40711		
200	HD EVO	07>	•		68B40728		

### TGB

50	101 S	99>	•		68B40710		
50	202T	99>	•		68B40716		
50	303 R	99>	•		68B40716		
50	309 RS	00>	•		68B40716		
50	AKROS	93	•		68B40710		
50	AKROS TEC.	94	•		68B40716		
50	ERGON	93	•		68B40711		
50	HIW'S	99>	•		68B40716		
50	TRIGGER	99>	•		68B40716		
90	101 S	99>	•		68B40710		
90	202T	99>	•		68B40716		
90	AKROS	99>	•		68B40716		
90	HIW'S	99>	•		68B40716		
90	TRIGGER	99>	•		68B40716		
125	202 T	99>	•		68B40716		
125	303 R	99>	•		68B40716		
125	309 RS	00>	•		68B40716		
150	303 R	00>	•		68B40716		
150	309 RS	00>	•		68B40716		

### TM

125	GS-MC	90>92	•				68B40756
-----	-------	-------	---	--	--	--	----------

### TRIUMPH

600	BABY SPEED	01>02	••				68B40749
600	DAYTONA	03>07	••				68B40749
600	SPEED FOUR	03>06	••				68B40749
600	TT	00>03	••				68B40749
675	DAYTONA TRIPLE	06>09	••		<b>78B40862</b>		68B40749
675	SPEED TRIPLE	07>09	••		<b>78B40862</b>		68B40749



Genuine

Serie Oro

Genuine

Serie Oro

**TRIUMPH**

675	STREET TRIPLE R	07>09	••		<b>78B40862</b>		68B40749
855	T 509 SPEED TRIPLE	97>98	••				68B40749
855	T 509 SPEED TRIPLE	99>	••				68B40749
900	SPEED TRIPLE T509	97>98	••		<b>78B40874</b>		68B40749
900	SPEED TRIPLE	99>	••				68B40749
900	TIGER	93>98	••		68B407E9		
950	T 595 DAYTONA	96>98	••		<b>78B40874</b>		68B40749
950	T 955 DAYTONA	99>06	••				68B40749
955	DAYTONA T955I	99>01	••		<b>78B40874</b>		68B40749
955	DAYTONA T955I	02>06	••		<b>78B40873</b>		68B40749
955	SPEED TRIPLE T955	99>01	••		<b>78B40874</b>		68B40749
955	SPEED TRIPLE T955	02>04	••		<b>78B40873</b>		68B40749
955	SPRINT RS	00>04	••		<b>78B40874</b>		68B407A4
955	SPRINT ST	98>04	••		<b>78B40874</b>		68B407A4
1050	SPEED TRIPLE S	05>07	••		<b>78B40881</b>		68B40749
1050	SPEED TRIPLE S	08>10	••		<b>78B40872</b>		68B40749
1050	SPRINT ST	05>08	••		<b>78B40873</b>		68B407A4
1050	TIGER/ABS	07>08	••		<b>78B40881</b>		68B407A4

**VOXAN**

995	BLACK MAGIC	06	••		<b>78B40870</b>		
996	CAFE' RACER	97>06	••	108489982	<b>78B40870</b>		
1000	V ROADSTER	97>06	••	108489982	<b>78B40870</b>		

**YAMAHA**

50	AEROX	97>	•	108200010	68B40716	108200010	68B40716
50	AEROX REPLICA	97>	•	108200010	68B40716	108200010	68B40716
50	AEROX ROSSI	04>	•	108200010	68B40716	108200010	68B40716
50	AXIS	95>96	•		68B40710		
50	BREEZE	94>	•		68B40710		
50	BW'S	93>98	•		68B40710		
50	BW'S NEXT GENERATION	01>	•		68B40716		
50	CRZ	92>	•		68B40710		
50	JOG	01>	•		68B40716		
50	JOG-Z	93	•		68B40710		
50	JOG-Z	91>	•		68B40710		
50	JOGZR	01>	•		68B40716		
50	NEOS	96	•	108489930	68B40717		
50	OVETTO	96>	•	108489930	68B40717		
50	SLIDER	00>	•	108200010	68B40716		
50	TZR	93>02	•	108200045	68B40791		
80	ZEST	95	•		68B40710		
80	ZEST YE	97>98	•		68B40710		
90	JOG-Z	91>	•		68B40710		
100	AEROX	00>	•	108200010	68B40716	108200010	68B40716
100	NEOS	96	•	108489930	68B40717		
100	NEOS	00>	•	108489930	68B40717		
125	DT R	92>03	•				68B40756
125	MAJESTY	01>	•	108489926		108200011	
125	MAJESTY	98>00	•	108489926			
125	MAXSTER	01	•	108200046		108489923	
125	SR	95>	•				68B407E4
125	TDR	89>99	•	108489982	<b>78B40870</b>		68B40756
125	TDR R	91>	•	108489993	<b>78B40870</b>		
125	TEO'S	99>02	•	108489926		108200011	
125	TEO'S	03>	•	108489926		108489923	
125	TZR	89>92	•		<b>78B40870</b>		
125	TZR R	91>	•	108489993	<b>78B40870</b>		
125	WR	89	•				68B40756
125	WR	90>97	•				68B40756
125	WR	01>07	•		<b>78B40813</b>		68B40790
125	X CITY	08>	•		68B407E6		68B40778
125	X MAX	05>	•		68B407C2		68B40778
125	" "	" "	•		<b>78B40817</b>		68B40778
125	XV S DRAG STAR	01>02	•		68B407D0		
125	XV S VIRAGO	97>00	•		68B407D0		
125	XV VIRAGO	97>00	•		68B407D0		
125	YZ	85>89	•				68B40756
125	YZ	90>97	•				68B40756





Genuine

Serie Oro

Genuine

Serie Oro

## YAMAHA

125	YZ	01>01	•		<b>78B40813</b>		
125	YZ	02>	•		<b>78B40813</b>		68B40790
150	MAJESTY	98>00	•	108489926			
150	MAJESTY	01>	•	108489926		108200011	
150	MAXSTER	01>	•	108200046		108489923	
150	TEO'S	03	•		68B40791	108489923	
200	DT	89	•				68B40755
200	WR	92>	•				68B40756
250	FZX ZEAL	91>	•		<b>78B40870</b>		
250	MAJESTY	96>97	•		68B40791		
250	MAJESTY/ABS	98>99	•		68B40791		68B40762
250	MAJESTY	00>05	•		68B40791		68B40765
250	TDR	89>92	•		<b>78B40870</b>		
250	TT	>00	•				68B40756
250	TZR	89	••		<b>78B40870</b>		
250	TZR	90>92	••		<b>78B40870</b>		
250	WR	90>91	•				68B40756
250	WR	92>97	•				68B40756
250	WR	01>07	•		<b>78B40813</b>		68B40790
250	WR F	01>02	•		<b>78B40813</b>		68B40790
250	WR F	03>	•		<b>78B40813</b>		68B40790
250	X-CITY	07>	•		68B407E6		68B40778
250	X-MAX	05>	•		68B407C2		68B40778
250	" "	" "	•		<b>78B40817</b>		68B40778
250	XV S VIRAGO	97>00	•		68B407D0		
250	YZ	85>89	•				68B40756
250	YZ	90>97	•				68B40756
250	YZ	01	•		<b>78B40813</b>		
250	YZ	02>	•		<b>78B40813</b>		68B40790
250	YZ F	01>02	•		<b>78B40813</b>		
250	YZ F	03>	•		<b>78B40813</b>		68B40790
250	YZF F	03>05	•		<b>78B40813</b>		
300	VERSITY	03>04	•		68B407C5		68B40778
300	XC VERSITY	04>06	•		68B407C5		68B40778
350	RD LC	85>93	•		68B407E4		68B407E4
360	YZ	89	•				68B40756
360	YZ	90>93	•				68B40756
400	FZ R	85>87	••		68B407E4		
400	MAJESTY	04	•		68B407C2		68B407C4
400	" "	" "	•		78B40817		68B407C4
400	MAJESTY	05>07	••		68B407C2		68B407C4
400	" "	" "	••		<b>78B40817</b>		68B407C4
400	MAJESTY	08>	••		68B407C3		68B407C4
400	SRX	91>	•				68B40791
400	WR F	98>00	•				68B40756
400	XJR	95>00	•				68B40791
400	YZ F	98>00	•				68B40756
426	WR F	01>02	•		<b>78B40813</b>		68B40790
426	YZ F	01>	•		<b>78B40813</b>		68B40790
450	WR F	03>	•		<b>78B40813</b>		68B40790
450	YZ F	03>	•		<b>78B40813</b>		68B40790
500	RD LC	84>88	••		68B407E4		68B407C9
500	T-MAX	01>03	••		68B407D0		68B407E4
500	T-MAX/BLACK MAX	04>07	••		<b>78B40817</b>		68B407E4
500	T-MAX/ABS	08>	••		<b>78B40818</b>		68B407E4
500	WR	92>93	•				68B40756
600	DIVERSION	09>	••		<b>78B40831</b>		68B40793
600	FZ6-FAZER	04>08	••		<b>78B40831</b>		68B40793
600	FZ6 S2-FAZER	07>08	••		<b>78B40831</b>		68B40793
600	FZR	89	••				68B407C9
600	FZR	90>95	••				68B407C9
600	FZS FAZER	98>00	••				68B407C9
600	FZS FAZER	01>03	••				68B407C9
600	FZS FAZER	04>08	••				68B40793
600	SRX	86>	••		68B407E4		68B407C9
600	TT E	97>00	•		68B407C1		68B40756
600	TT R	98>00	•		68B407C1		68B40756

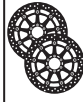

Genuine

Serie Oro

Genuine

Serie Oro

**YAMAHA**

600	TT RE	04>07	•		68B407C1	68B40756
600	XJ F	83>90	•		68B407E4	68B407E4
600	XJ DIVERSION	91>97	•			68B407C9
600	XJ DIVERSION	98>03	••		<b>78B40830</b>	68B407C9
600	XJ N	98>03	••		<b>78B40830</b>	68B40791
600	XJ 6	09>10	••		<b>78B40831</b>	68B40793
600	XT ALL MODELS	83>85	•		68B407E4	
600	XT ALL MODELS	86>89	•		68B407E4	68B40742
600	XT-E	90>94	•		68B407E4	68B40742
600	XT-E	95>	•		68B407D0	68B40742
600	XT TENERE'	83>89	•		68B407E4	
600	XTZ TENERE'	86>91	•		68B407E4	68B40742
600	YZF R6	99>02	••		<b>78B40830</b>	68B40755
600	YZF R6	03>04	••		<b>78B40831</b>	68B40750
600	YZF R6	05>	••		<b>78B40860</b>	68B40750
600	YZF R THUNDER CAT	96>02	••		<b>78B40830</b>	68B407C9
660	MT-03	06>08	••		<b>78B40831</b>	68B40793
660	SZR	95>01	•		<b>78B40870</b>	
660	XT R	04>10	•			68B407C9
660	XT X	04>09	•			68B407C9
660	XTZ TENERE'	91>96	•		68B407D0	68B40742
660	XTZ TENERE'	08>	•			68B407C9
750	FZ GENESIS	89>92	••			68B407E4
750	FZ	85>88	•		68B407E4	68B407E4
750	FZR R	89>92	••		<b>78B40870</b>	
750	FZX	87>	••		68B407E4	68B407E4
750	SUPERTENERE'	89>	••	108200045	68B40791	68B407C9
750	XJ F	83>88	•		68B407E4	
750	XV VIRAGO	87>93	••		68B407E4	68B407E4
750	XV VIRAGO	94>00	••		68B407D0	
750	YZF R/SP	93>97	••			68B407C9
750	YZF R7	99>01	••			68B407C9
800	FZS FAZER	98>99	••			68B407C9
850	TDM	91>01	••			68B407C9
850	TRX	95>00	••			68B407C9
900	TDM	02>	••		<b>78B40830</b>	68B407C9
900	XJ F	83>90	••		68B407E4	
900	XJ DIVERSION	94>	••			68B407E4
1000	FZ1	06>	••		<b>78B40871</b>	68B40793
1000	FZ1 S FAZER	06>10	••			68B40793
1000	FZR	87>88	••			68B407E4
1000	FZR GENESIS	87>88	••		<b>78B40870</b>	68B407E4
1000	FZR EX-UP	89>90	••		<b>78B40870</b>	68B407E4
1000	FZR EX-UP	91	••		<b>78B40870</b>	68B407E4
1000	FZR EX-UP	92>93	••		<b>78B40870</b>	68B407E4
1000	FZR EX-UP	94>95	••		<b>78B40870</b>	68B407E4
1000	FZS FAZER	01>05	••		<b>78B40830</b>	68B407E4
1000	FZ1-S FAZER	06>	••		<b>78B40871</b>	68B40793
1000	YZF R1	98>01	••		<b>78B40830</b>	68B40791
1000	YZF R1	02>03	••		<b>78B40830</b>	68B40755
1000	YZF R1	04>06	••		<b>78B40871</b>	68B40750
1000	YZF R1	07>	••		<b>78B40860</b>	68B40750
1000	YZF R THUNDER ACE	96>98	••		<b>78B40830</b>	68B407C9
1000	YZF R1 SP (LIMITED EDITION)	06	••			68B40750
1100	BT BULLDOG	02>	••		<b>78B40830</b>	68B407E4
1100	XV VIRAGO	87>93	••		68B407E4	68B407E4
1200	XJR	95>98	••		<b>78B40870</b>	68B407E4
1200	XVZ VENTURE ROYALE	84>87	••		<b>78B40830</b>	
1300	FJR	03	••		<b>78B40830</b>	
1300	FJR A	06>	••			68B407D0
1300	FJR AS	06>	••			68B407D0
1300	XJR	99>	••		<b>78B40830</b>	68B407E4
1300	XJR SP	99>	••			68B407E4
1670	MT-01	05>	••			68B407E4
1700	XV PC ROAD STAR WARRIOR	02>07	••		<b>78B40830</b>	
1900	XV ROADLINER	06	••		<b>78B40830</b>	



**Disegni dischi e loro applicazioni**  
***Drawings of discs and their applications***  
**Dessins des disques et leurs applications**  
***Zeichnungen der Bremsscheiben und deren Anwendungen***  
**Diseños y aplicaciones de los discos**

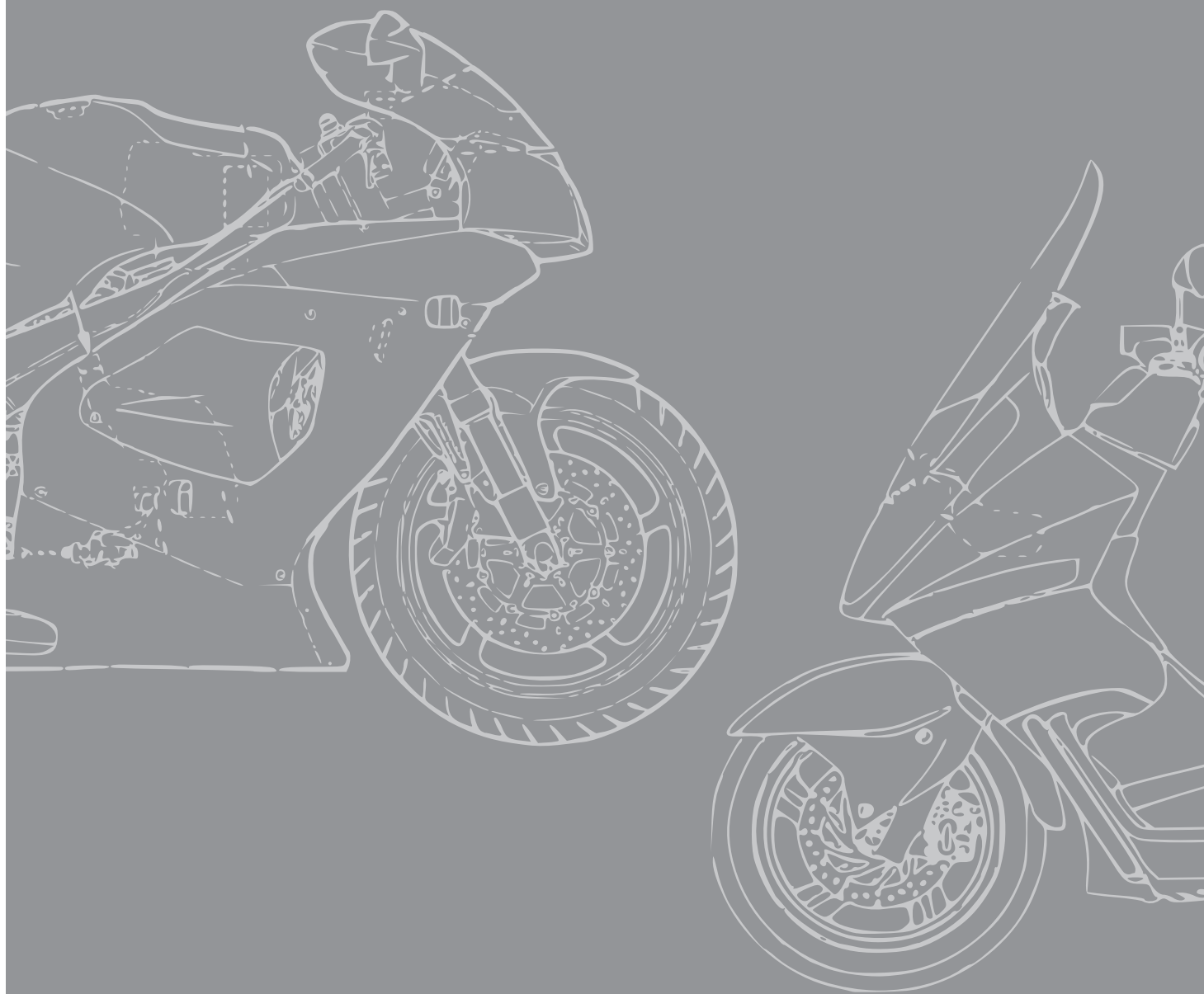

# 2

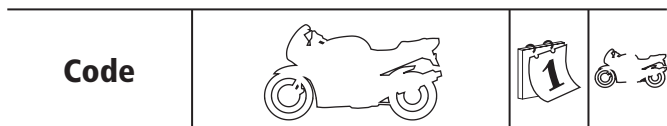

## 108200010

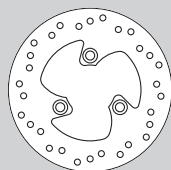

A = 190 B = 58  
C = 80 D = 10,5  
E = 3,5

### MBK

50	BOOSTER N.G.	01>04	•
50	F1 ASSISTANCE	01	•
50	NITRO	97>	• •
50	STUNT	00>	•
100	NITRO	00>	• •

### YAMAHA

50	AEROX	97>	• •
50	AEROX REPLICA	97>	• •
50	AEROX ROSSI	04>	• •
50	SLIDER	00>	•
100	AEROX	00>	•

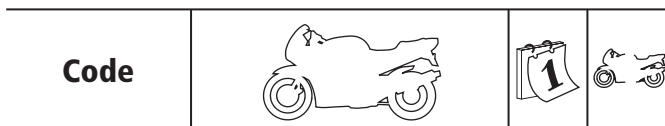

## 108200366

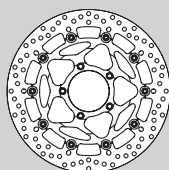

A = 320 B = 80  
C = 101,5 D = 8,5  
E = 4,5

### MV

910	BRUTALE R	06>08	•
1000	F4R TAMBURINI	06>08	•
1000	F4RR 312 RR	07>08	•
1078	F4	09>	•
1078	BRUTALE RR	09>	•

## 108200011

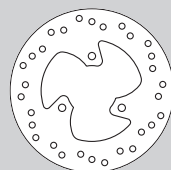

A = 190 B = 63  
C = 80 D = 8,5  
E = 00

### MBK

125	SKYLINER	02>	•
150	SKYLINER	01>	•

### YAMAHA

125	MAJESTY	01>	•
125	TEO'S	99>02	•
150	MAJESTY	01>	•

## 108200370

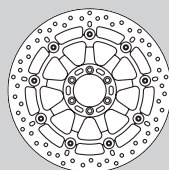

A = 320 B = 64  
C = 80 D = 8,5  
E = 4

### BENELLI

900	TORNADO 3 BIPOSTO	02>03	•
900	TORNADO 3 L.E.	03>06	•
900	TORNADO 3 RS	04>06	•
1100	TNT	04	•
1130	TNT	05>06	•
1130	TNT CAFE' RACER	05>07	•
1130	TNT RS	05>06	•
1130	TNT SPORT	05>	•
1130	TNT TITANIUM	05>07	•
1130	TORNADO TRE	06	•
1130	TRE-K	06>07	•

### BIMOTA

1000	DB5	05>	•
1000	DB6 DELIRIO	06>	•
1100	SB8K SANTAMONICA	04>	•

### DUCATI

996	996 R	01	•
998	998/F.E./MATRIX	02>	•

### KTM

625	SMC	05>08	•
640	DUKE II	03>06	•
640	LC4 Supermoto	05	•

### MONDIAL

999	PIEGA	03>	•
999	PIEGA EVO	03>	•
999	PIEGA NUDA	04>	•

### MOTO MORINI

998	9 1/2	06>09	•
1200	CORSARO	05>09	•

## 108200045

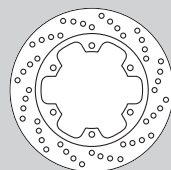

A = 245 B = 115  
C = 133 D = 8,5  
E = 4

### ITALJET

250	JUPITER	00>	•
-----	---------	-----	---

### YAMAHA

50	TZR	93>02	•
750	SUPERTENERE'	89>	•

## 108200046

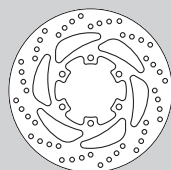

A = 245 B = 80  
C = 98 D = 8,5  
E = 4

### MBK

125	THUNDER	01	•
-----	---------	----	---

### YAMAHA

125	MAXSTER	01	•
150	MAXSTER	01>	•

## 108200372

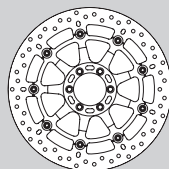



A = 320 B = 64  
C = 80 D = 8,5  
E = 4

### KTM

990	SUPERDUKE	05>	•
-----	-----------	-----	---

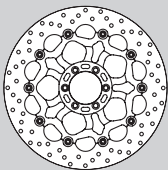

Code			
------	---	---	---

	<b>108200384</b>	<b>APRILIA</b>		
	1000 RSV	98>00	•	
	1000 RSV R	00	•	
	1000 RSV SP	99>00	•	
	1000 SL FALCO	00>04	•	
	<b>BIMOTA</b>			
	1000 SB8K GOBERT	04>06	•	
	<b>MOTO GUZZI</b>			
	1100 BREVA	05>07	•	
	1100 GRISO	05>08	•	
1100 SPORT	98>99	•		

A = 320 B = 64  
C = 80 D = 8,5  
E = 4,5

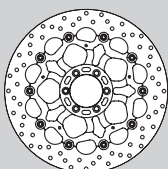
	<b>108200385</b>	<b>MOTO GUZZI</b>		
	850 NORGE T-GTL ABS	07>	•	
	1100 BREVA ABS	05>07	•	
	1200 BREVA ABS	08>09	•	
	1200 NORGE ABS	06	•	
	1200 SPORT ABS	06>07	•	

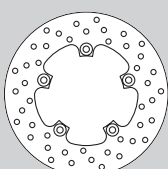

A = 320 B = 64  
C = 80 D = 8,5  
E = 4,5

	<b>108489923</b>	<b>APRILIA</b>		
	50 RS	99>05	•	
	50 TUONO	03>04	•	
	125 RS	96>	•	
	125 SCARABEO I.E.	08>	•	
	125 TUONO	04>05	•	
	200 SCARABEO LIGHT/I.E.	07>	•	
	250 RS	94>	•	
	400 SCARABEO LIGHT	07>	•	
	500 SCARABEO LIGHT	07>	•	
<b>MBK</b>				
125 THUNDER	01	•		
<b>MONDIAL</b>				
999 PIEGA	03>	•		
999 PIEGA EVO	03>	•		
999 PIEGA NUDA	04>	•		
999 RZ NUDA	02>	•		
999 RZ STARFIGHTER	02>	•		
<b>YAMAHA</b>				
125 MAXSTER	01	•		
125 TEO'S	03>	•		
150 MAXSTER	01>	•		
150 TEO'S	03	•		

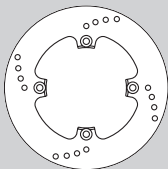
A = 220 B = 102  
C = 120 D = 8,5  
E = 4,5

	<b>108489924</b>	<b>DUCATI</b>		
	748 748	00>02	•	
	748 748 BIPOSTO	95>98	•	
	748 748 BIPOSTO	99>02	•	
	748 748 R	00	•	
	748 748 R	01>03	•	
	748 748 S	00>02	•	
	748 748 SP	95>97	•	
	748 748 SPS	98>99	•	
	900 MH EVOLUTION	01>02	•	
	916 916	94>96	•	
	916 916 BIPOSTO/SENNA	94>98	•	
	916 916 RACING	94>97	•	
	916 916 S/916 SP	94>96	•	
916 916 SPS	97>98	•		
996 996/S/SPS/SPS II/SPS III	99>01	•		

A = 220 B = 108  
C = 125 D = 8,5  
E = 6

Code			
------	---	---	---

996 996 R	01	•
998 998/F.E./MATRIX	02>	•
998 998 R/S	02>	•

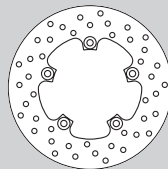
	<b>108489925</b>	<b>APRILIA</b>		
	1000 RSV	98>00	•	
	1000 RSV	01>03	•	
	1000 RSV FACTORY	03>07	•	
	1000 RSV R	00	•	
	1000 RSV R	01>08	•	
	1000 RSV4 FACTORY	09>	•	
	1000 RSV4 R	10>	•	
	1000 RSV SP	99>00	•	
	1000 SL FALCO	00>04	•	
1000 TUONO	03>	•		
1000 TUONO FIGHTER	02>05	•		
1000 TUONO R	03>09	•		
1000 TUONO RACING	04>05	•		
<b>BENELLI</b>				
900 TORNADO 3 L.E.	03>06	•		
900 TORNADO 3 RS	04>06	•		
<b>LAVERDA</b>				
1000 SFC LIMITED EDITION	03>	•		

A = 220 B = 102  
C = 120 D = 8,5  
E = 5

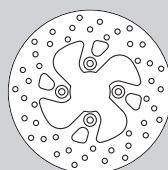
	<b>108489926</b>	<b>MBK</b>		
	125 DOODO	00>	•	
	125 SKYLINER	99>01	•	
	125 SKYLINER	02>	•	
	150 DOODO	01>	•	
	150 SKYLINER	00	•	
	150 SKYLINER	01>	•	
	180 SKYLINER	03>	•	
	<b>YAMAHA</b>			
	125 MAJESTY	01>	•	
125 MAJESTY	98>00	•		
125 TEO'S	99>02	•		
125 TEO'S	03>	•		
150 MAJESTY	98>00	•		
150 MAJESTY	01>	•		

A = 220 B = 54  
C = 76 D = 8,5  
E = 4,5

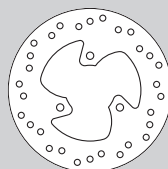
	<b>108489930</b>	<b>APRILIA</b>		
	50 AREA 51	98>00	•	
	50 AREA 51 SUPERBIKE	00>01	•	
	50 GULLIVER	95>00	•	
	50 HABANA	99>	•	
	50 HABANA CUSTOM	99>	•	
	50 MCGULLIVER	95>	•	
	50 MOJITO	04>08	•	
	50 MOJITO CUSTOM	99>03	•	
	50 MOJITO RETRO	99>03	•	
	50 RALLY	92>96	•	
	50 RALLY	97>	•	
	50 RALLY AC	96>	•	
	50 RALLY LC	92>96	•	
	50 RALLY LC	97>	•	
	50 SCARABEO	98>05	•	
	50 SCARABEO BRIGHT/DE LUXE	98>	•	
	50 SCARABEO DITECH	02>04	•	
	50 SR CAPIROSSI	98	•	
	50 SR DITECH	00>03	•	
	50 SR EUROPA	93>	•	
	50 SR LC	94>96	•	
	50 SR R	05>	•	
	50 SR R FACTORY	03>04	•	
	50 SR R FACTORY	05>08	•	
	50 SR R/R FACTORY	09>	•	

A = 190 B = 58  
C = 80 D = 8,5  
E = 3,5

**Code**

50	SR R/R FACTORY REPLICA SBK	10>	• •
50	SR RACING/STEALTH LC	97>99	• •
50	SR STREET	03>08	•
50	SR URBAN KID	93>	•
50	SR VIPER-REPLICA	94>	•
50	SR WWW. NETSCAPER	97>01	•
50	VIPER-REPLICA	94>	•
125	HABANA	99>	•
125	HABANA CUSTOM	00>	•
125	HABANA DITECH	02>	•
125	LEONARDO	95>98	•
125	MOJITO	03>08	•
125	MOJITO CUSTOM	99>01	•
125	MOJITO RETRO	99>01	•
125	SR	99>	• •
125	SR REPLICA	99>01	• •
150	LEONARDO	96>98	•
150	MOJITO	03>07	•
150	SR	99>01	• •
150	SR REPLICA	99>	• •

**FANTIC**

50	LEADER	95	•
----	--------	----	---

**GILERA**

50	STORM	96>01	•
50	TYPHOON	96	•
50	TYPHOON BENETTON	93>95	•
50	TYPHOON MARTINI	96	•
50	TYPHOON XR	96	•
125	RUNNER	95	•
125	TYPHOON XR	95>	•

**KL**

50	HELIOS	98>	•
50	KRYPTON	99>	•
50	XR7	98>	•
125	NOX	00	•
125	PROXY	01>	•
125	PULSAR	00	•
150	NOX	00	•
150	PROXY	01>	•
150	PULSAR	00	•

**MBK**

50	NEOS	94>	•
50	OVETTO	96	•
100	OVETTO	00>	•

**MONDIAL**

50	XR7	99>	•
----	-----	-----	---

**PIAGGIO**

50	NTT	96	•
50	STORM	94>	•
50	TYPHOON	94>	•
80	TYPHOON	96>	•
125	TYPHOON	96>	•
125	TYPHOON CATALIZZATO	02>	•

**YAMAHA**

50	NEOS	96	•
50	OVETTO	96>	•
100	NEOS	96	•
100	NEOS	00>	•

**Code****108489932****HONDA**

90	YUPI	98>	•
----	------	-----	---

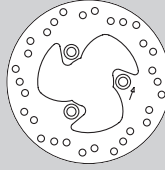

A = 190 B = 58  
C = 80 D = 10,6  
E = 3,5

**108489943****MOTO GUZZI**

1000	DAYTONA RS	96>	•
1100	CALIFORNIA ALUMINIUM	03>	•
1100	CALIFORNIA EV	97>02	•
1100	CALIFORNIA EV/TOURING	03>	•
1100	CALIFORNIA JACKAL	99>01	•
1100	CALIFORNIA SPECIAL	99>00	•
1100	CALIFORNIA TITANIUM	03>	•
1100	METAL	02>	•
1100	SPORT	00>	•
1100	STONE	01>02	•
1100	STONE	03>	•
1100	V 11	00	•
1100	V 11 BALLABIO	03>	•
1100	V 11 CAFE' SPORT	03>	•
1100	V 11 COPPA ITALIA	03>	•
1100	V 11 LE MANS	01>	•
1100	V 11 LE MANS NERO CORSA	03>	•
1100	V 11 LE MANS ROSSO CORSA	03>	•
1100	V 11 NAKED	01>02	•
1100	V 11 NAKED	03>	•
1100	V 11 SPORT	01>02	•

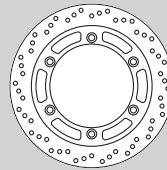

A = 282 B = 144  
C = 166 D = 10,5  
E = 5

**108489944****APRILIA**

1000	ETV CAPONORD ABS	04>	•
------	------------------	-----	---

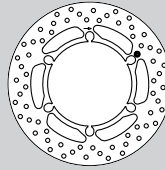

A = 272 B = 144  
C = 158 D = 13,8  
E = 5

**108489946****APRILIA**

1000	ETV CAPONORD	01>	•
------	--------------	-----	---

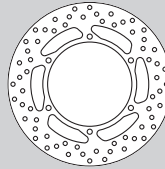

A = 272 B = 140  
C = 158 D = 8,5  
E = 5

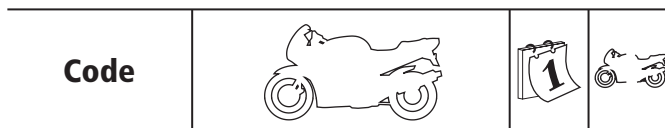

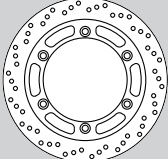
	<b>108489948</b>	<b>MOTO GUZZI</b>		
		1000 V 10 CENTAURO	97>99	•
		1000 V 10 CENTAURO GT	99>00	•
		1000 V 10 CENTAURO SPORT	98>00	•
		1100 SPORT	98>99	•
		1100 SPORT I.E.	96>99	•
<p>A = 282 B = 144 C = 166 D = 10,5 E = 5</p>				

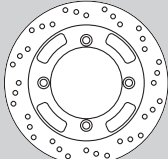
	<b>108489952</b>	<b>CAGIVA</b>		
		750 ELEFANT	94>95	•
		900 ELEFANT I.E.	90>96	•
		900 GRAN CANYON	99>04	•
<p>A = 240 B = 105 C = 125 D = 10,5 E = 5</p>				

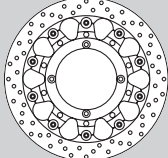
	<b>108489966</b>	<b>HUSQVARNA</b>		
		450 SMR	03>05	•
		630 SM R	03>05	•
<p>A = 320 B = 120 C = 135 D = 8,5 E = 5</p>				

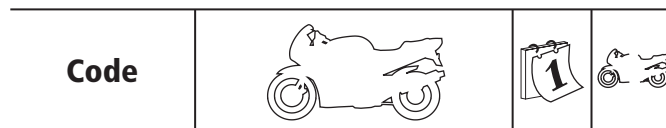

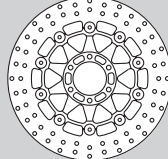

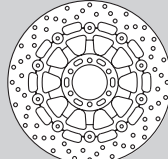
	<b>108489975</b>	<b>APRILIA</b>		
		250 RS	94>	•
		<b>CAGIVA</b>		
		650 RAPTOR	00>	•
		650 V-RAPTOR	01>	•
		1000 RAPTOR	00>	•
		1000 V-RAPTOR	01>	•
		1000 XTRA RAPTOR	02>	•
<p>A = 298 B = 61 C = 80 D = 8,5 E = 4</p>				

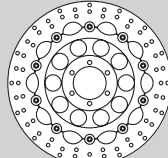
	<b>108489976</b>	<b>APRILIA</b>		
		1000 RST FUTURA	01>	•
<p>A = 298 B = 64 C = 80 D = 8,5 E = 5</p>				

	<b>108489982</b>	<b>APRILIA</b>		
		125 EXTREMA	97>	•
		125 RS EXTREMA	89>91	•
		125 SPORT PRODUCTION	92	•
		<b>CAGIVA</b>		
		125 MITO 2	92>	•
		125 PLANET	97>03	•
		125 RAPTOR	04>06	•
		125 SUPERCITY	92>00	•
		500 RIVER	99>01	•
		600 RIVER	95>97	•
<p>A = 320 B = 64 C = 80 D = 8,5 E = 4</p>				

		<b>DUCATI</b>		
	350	350 SUPERSPORT	91>92	•
	400	M400	95>97	•
	400	400 SUPERSPORT	93>97	•
	600	M600	93>	•
	600	M600/DARK	98	•
	600	M600 DARK CITY	99	•
	600	600 SUPERSPORT	91>00	•
	748	748 BIPOSTO	95>98	•
	750	M750 BIDISCO	96>97	•
	750	M750 MONODISCO	96>97	•
	750	M750	98>99	•
	750	750 SUPERSPORT	91>99	•
	851	851	89>91	•
	851	851 SP III	91	•
	888	888 SUPERBIKE Strada	94>95	•
	900	M900 CROMO	98	•
	900	M900 DARK CITY	99	•
	900	M900 SPECIAL	98	•
	900	SL SUPERLIGHT	93>97	•
	900	900 SS	91>99	•
	907	907 i.e.	92>93	•
	916	916	94>96	•
	916	916 BIPOSTO/SENNA	94>98	•
	916	M S4	01	•
	916	ST4	99	•
	944	ST2	97>99	•
		<b>GILERA</b>		
	125	GFR	93>	•

Code			
------	---	---	---

### LAVERDA

650 GHOST	96>99	•
650 SPORT	95>01	•
668 DIAMANTE	96>98	•
668 STRIKE	97>99	•
750 BLACK STRIKE	00>	•
750 FORMULA	97>98	•
750 SPORT	97>98	•
800 T-8	98	•
800 TSS	98	•

### MOTO GUZZI

1000 DAYTONA RACING	96	•
1000 DAYTONA RS	96>	•
1000 V 10 CENTAURO	97>99	•
1000 V 10 CENTAURO GT	99>00	•
1000 V 10 CENTAURO SPORT	98>00	•
1100 CALIFORNIA ALUMINIUM	03>	•
1100 CALIFORNIA EV	97>02	•
1100 CALIFORNIA JACKAL	99>01	•
1100 CALIFORNIA SPECIAL	99>00	•
1100 CALIFORNIA TITANIUM	03>	•
1100 SPORT	94>96	•
1100 SPORT I.E.	96>99	•
1100 STONE	01>02	•
1100 V 11	00	•

### VOXAN

996 CAFE' RACER	97>06	•
1000 V ROADSTER	97>06	•

### YAMAHA

125 TDR	89>99	•
---------	-------	---

### 108489983

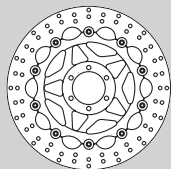

A = 320 B = 64  
C = 80 D = 8,5  
E = 4

### APRILIA

125 MX	04>07	•
125 RS	96>	•
125 TUONO	04>05	•

### 108489991

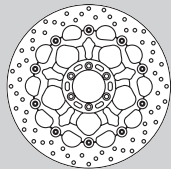

A = 320 B = 64  
C = 80 D = 8,5  
E = 5

### DUCATI

748 748 R	00	•
748 748 S	00>02	•
996 996/S/SPS/SPS II/SPS III	99>01	•
1000 MS4R	03>04	•

### Code



### 108489993

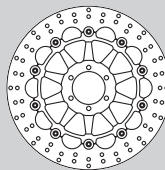

A = 320 B = 64  
C = 80 D = 8,5  
E = 4

### DUCATI

400 M400	01>06	•
400 M400 DARK	03>	•
600 M600 MET./DARK/DARK CITY	00>01	•
620 M620 I.E. DARK SD	04>05	•
620 M620 S I.E.	02>04	•
620 MULTISTRADA 620 SD	04>	•
620 SUPERSPORT	02>05	•
748 748	00>02	•
748 748 BIPOSTO	99>02	•
750 M750/DARK/METALLIC	00>01	•
750 M750 DARK I.E.	02	•
750 750 SPORT	01>02	•
750 750 SUPERSPORT I.E.	00>02	•
800 M800 S I.E.	03>04	•
800 800 SUPERSPORT/S	03>04	•
800 800 SUPERSPORT	06	•
900 M900 I.E.	00	•
900 M900 CROMO I.E.	00>01	•
900 M900 DARK I.E.	00>02	•
900 M900 METALLIC I.E.	00>01	•
900 M900 S I.E.	00>01	•
900 900 SS I.E.	00>02	•
900 900 SS S I.E.	02	•
944 ST2	00>03	•
1000 M1000 S I.E.	03>	•
1000 1000SS S	03>	•

### MOTO GUZZI

750 BREVA	03>07	•
750 NEVADA	03>07	•
750 NEVADA CLASSIC I.E.	03>	•
750 NEVADA CLUB	03>	•
1100 CALIFORNIA EV/TOURING	03>	•
1100 METAL	02>	•
1100 SPORT	00>	•
1100 STONE	03>	•
1100 V 11 BALLABIO	03>	•
1100 V 11 CAFE' SPORT	03>	•
1100 V 11 COPPA ITALIA	03>	•
1100 V 11 LE MANS	01>	•
1100 V 11 LE MANS NERO CORSA	03>	•
1100 V 11 LE MANS ROSSO CORSA	03>	•
1100 V 11 NAKED	01>02	•
1100 V 11 SPORT	01>02	•

### YAMAHA

125 TDR R	91>	•
125 TZR R	91>	•

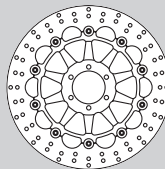

### 108489996



A = 320 B = 64  
C = 80 D = 8,5  
E = 4

### HUSQVARNA

510 SMR	05	•
570 SM R	01>04	•
610 LT	00>	•
610 SM	05	•
610 SM	98>99	•
610 SM S	00>04	•

<b>Code</b>			
-------------	---	---	---

## 108489998

### DUCATI

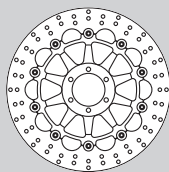

A = 320 B = 64  
C = 80 D = 8,5  
E = 4

696	MONSTER 696/ABS	08>10	•
900	MH EVOLUTION	01>02	•
1000	GT	06>	•
1000	MS2R	06>07	•
1000	PAUL SMART I.E.	06>07	•
1000	SPORT	06>07	•
1000	SPORT S	07>	•

## 208200040

### BENELLI

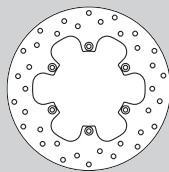

A = 240 B = 110  
C = 124 D = 6,5  
E = 5

900	TORNADO 3 BIPOSTO	02>03	•
-----	-------------------	-------	---

## 208489955

### APRILIA

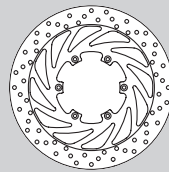

A = 300 B = 105  
C = 120 D = 6,5  
E = 4,5

650	CUBE	93>00	•
650	CUBE	01>	•
650	PEGASO	91>92	•
650	PEGASO	93>00	•
650	PEGASO I.E.	01>04	•
650	PEGASO TRAIL	05>08	•

### BMW

650	F 650	93>01	•
650	F 650 CS	02>07	•
650	F 650 DAKAR	00>02	•
650	F 650 FL	93>00	•
650	F 650 GS/ABS	00>07	•
650	F 650 GS/ABS	08>	•
650	F 650 STRADA/ST	97>01	•
650	G 650 X CHAL./COUNTRY	07>09	•
800	F 800 GS	09>	•

Code

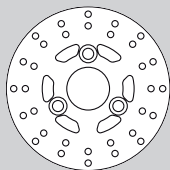
**68B40710**

A = 155 B = 40,5  
C = 66 D = 10,5  
E = 3,5

**AGRATI GARELLI**

50	BIG WHEEL	93>	• • •
50	BIP-RACING	94>	•
50	GRINTA	95	•
50	PONY SR	95	•
50	QUEENIE	95>	•

**APRILIA**

50	AMICO-F- X-SPORT	92>94	•
50	SONIC GP /SPICE	98>08	•

**ATALA**

50	BYTE	97>00	•
----	------	-------	---

**BS VILLA**

50	AX	93>	•
50	GZ	93>	•
50	ZX	93>	•

**DERBI**

50	VAMOS	95>97	•
----	-------	-------	---

**FANTIC**

50	BIG WHEEL	91>94	•
50	FLYING TIGER	96	•
50	GRINTA	95>	•
50	QUEENIE	95	•

**GILERA**

50	EASY MOVING	97>	•
----	-------------	-----	---

**ITALJET**

50	BAZOOKA	92>97	•
50	PISTA	93>	•
50	SCOOP	93	•
50	YANKEE	93>	•

**KL**

50	BOMBER	94	•
50	INVADER	98>	•
50	KRX	98>	•
50	RACER	94	•

**LEM**

50	FLASH	93	•
----	-------	----	---

**MBK**

50	BOOSTER all model	96>99	•
50	BOOSTER R	93>95	•
50	EVOLIS	92>	•
50	FIZZ	94>	•
50	FORTE	94>	•
50	TARGET	92>94	•
50	TRACK	95>	•
80	EVOLIS	94>	•

**MONDIAL**

50	MX1	99>	•
50	MX3	99>	•

**PEUGEOT**

50	LUDIX SNAKE/TREND	03>	•
50	SVM	97	•
50	V-CLIC	09>	•

**PGO**

50	BIG MAX	94>02	•
50	BIG MAX SPORT	96>	•
50	MEGA FIFTY	99>	•
50	MOT	97>	•
50	PMX	97>	•
50	TORNADO	96>02	•
80	BIG MAX	95>	•
90	BIG MAX	97>00	•

**PIAGGIO**

50	ZIP DISCO	96>	•
50	ZIP FAST RIDER	93>00	•
50	ZIP SPORT RST	95>	•

**SIAMOTO**

50	BINGO	99	•
125	BINGO	99	•

Code

**TGB**

50	101 S	99>	•
50	AKROS	93	•
90	101 S	99>	•

**YAMAHA**

50	AXIS	95>96	•
50	BREEZE	94>	•
50	BW'S	93>98	•
50	CRZ	92>	•
50	JOG-Z	93	•
50	JOG-Z	91>	•
80	ZEST	95	•
80	ZEST YE	97>98	•
90	JOG-Z	91>	•

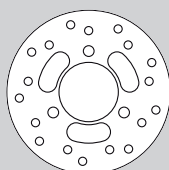
**68B40711**

A = 160 B = 58  
C = 80 D = 10,5  
E = 4

**CAGIVA**

50	CITY	92>94	•
50	CITY LUCKY	95>	•
80	CITY	93>	•

**DAELIM**

50	MESSAGE II	98>	•
50	VIVO	99>	•
100	DELFINO	99>	•

**FANTIC**

50	SPIKE	96	•
----	-------	----	---

**HONDA**

50	GP DIO	94>	•
50	NS AERO	90>97	•
50	SFX	88>96	•
50	SR DIO	90>93	•
50	SR DIO	00>	•
50	SXR	98>00	•
50	SXR SHADOW	90>93	•
50	ZX DIO	98>	•

**ITALJET**

50	CRUISE	94>	•
----	--------	-----	---

**SYM**

50	CHA-CHA	99>	•
50	CINDERELLA	99>00	•
50	SUPER FANCY	99>	•
100	CINDERELLA	99>00	•
100	SUPER FANCY	95>	•
125	ATTILA	00>	•
125	SUPER DUKE	00>	•
150	ATTILA	00>	•

**TGB**

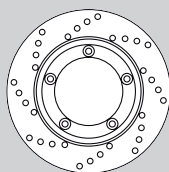

50	ERGON	93	•
----	-------	----	---

**68B40712**

A = 175 B = 73  
C = 86 D = 6,5  
E = 3,5

**PIAGGIO**

125	HEXAGON	94>97	•
150	HEXAGON	94>97	•
180	HEXAGON	94>98	•

Code			
------	---	---	---

## 68B40713

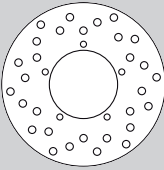

A = 175 B = 73  
C = 86 D = 6,5  
E = 4

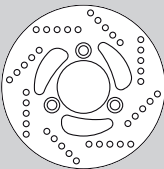

<b>DERBI</b>			
50 GP1	01>02		•
50 GP1 REPLICA	01>02		•
125 PREDATOR	99		•
<b>DERBI</b>			
180 PREDATOR	99		•
<b>GILERA</b>			
50 RUNNER	01>		•
50 RUNNER DD	96>		•
50 RUNNER PUER JET	03>		•
50 RUNNER RACING REPLICA	03>		•
50 RUNNER SP	00>01		•
50 STALKER	98>		•
50 STORM	96>01		•
<b>PIAGGIO</b>			
50 NRG EXTREME	99>00		•
50 NRG MC3	01>04		•
50 NRG POWER DD	05>10		•
50 NRG POWER DD SERIE SPEC.	07>08		•
50 NRG POWER PUREJET	04>09		•
50 NRG PUREJET	02>04		•
50 NRG PUREJET	10		•
50 NRG RST MC2	96>98		•
50 STALKER	97>99		•
50 ZIP	00>04		•
50 ZIP 2T	08>10		•
50 ZIP 4T	00>10		•
50 ZIP II	01>		•
100 ZIP 4T	06>08		•
125 ZIP	00>02		•

## 68B40714



A = 180 B = 58  
C = 80 D = 10,5  
E = 4

<b>HYOSUNG</b>			
50 PLUS	95>		•
50 SUPER CAB	95>		•
50 SUPER CAB PLUS	98>		•
<b>KYMCO</b>			
50 AGILITY R 10"	06>		•
50 AGILITY R 12"	06>		•
50 DINK	98>02		•
50 FEVER ZX	99>		•
50 MXER	02>03		•
50 SUPER 9	02>		•
50 TOP BOY	99>		•
50 YUP SP	00>		•
50 VITALITY	08>		•
90 YUP SP	95>		•
125 AGILITY R 12"	06>08		•
125 B & W	00>		•
125 DINK	98>		•
125 DINK CLASSIC	02>		•
125 DINK LX	99>01		•
125 MXER	02>03		•
150 B&W	00>		•
150 DINK	98>01		•
150 DINK LX	98>01		•
150 MXER	02>03		•
200 DINK CLASSIC	03>		•
250 B & W	00>		•
300 MXU	06>		•
<b>MOTOR UNION</b>			
125 MAXI	99>		•
150 MIDI	99>		•
150 MAXI	99>		•
400 MAXI	99>		•
<b>PEUGEOT</b>			
50 SPEED FIGHT (Brembo caliper)	96>		•
50 SPEEDFIGHT (AJP caliper)	00>		•
50 X-RACE	02>05		•

Code			
------	---	---	---

100 SPEEDFIGHT (PinzaAJP)	98>02		•
---------------------------	-------	--	---

## 68B40715

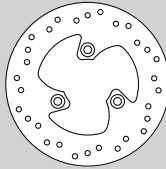

A = 190 B = 58  
C = 80 D = 10,5  
E = 4



<b>MALAGUTI</b>			
50 CIAK	99>01		•
50 CIAK TD	00>01		•
50 CROSSER	95>98		•
50 CROSSEREL	97>		•
50 F12 PHANTOM	94>98		•
50 F12 PHANTOM DIGIT	00>02		•
50 F12 PHANTOM DIGIT (all mod.)	03>		•
50 F12 PHANTOM CAPIREX	03>		•
50 F12 PHANTOM FOG GY	00>		•
50 F12 PHANTOM LC E1	99>00		•
50 F12 PHANTOM LC	94>98		•
50 F12 PHANTOM LC TWIN DISKS	98>00		•
50 F12 PHANTOM LC REST. E1	01>02		•
50 F12 PHANTOM LC REST. E2	02>06		•
50 F12 PHANTOM LC REST. E3	03>04		•
50 F12 PHANTOM SPECTRUM	00>		•
50 F15 FIRE FOX	96>98		•
50 F15 FIRE FOX LC	96>98		•
50 F15 FIRE FOX (Twin Disks/Spec.)	98>99		•
50 F15 FIRE FOX E2	02>03		•
50 F15 FIRE FOX FUN	99>00		•
50 F15 FIRE FOX LC-TDS REST. E1	99>01		•
50 F15 FIRE FOX LC REST. E2	04>05		•
50 F15 FIRE FOX REST. E2	03>04		•
50 F15 FIRE FOX FUN	03>		•
50 F15 FIRE FOX (Twin Disks/Digit Kat)	98>00		•
50 SILVERFOX	96>		•
100 CIAK	99>		•
100 F12 PHANTOM	99>		•
<b>PEUGEOT</b>			
50 TKR STREET ZONE	03>		•

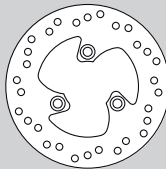

## 68B40716





A = 190 B = 58  
C = 80 D = 8,5  
E = 3,5

<b>ATALA</b>			
50 AT 18	98		•
50 HACKER AT 12	96>		•
50 SKEGGIA	99>		•
<b>BENELLI</b>			
50 491 ARMY/RACING/SUPERBIKE	97>		•
50 491 GT/SPORT	97>		•
50 491 NAKED	99>		•
50 491 ST	01>		•
50 K2 ARIA-KAT-ACQUA	98>		•
50 K2 NAMUR	99>		•
100 K2 ARIA	99>		•
100 NAKED	99>02		•
<b>BETA</b>			
50 ARK	96>98		•
50 ARK	99>		•
50 CHRONO "13"	94>		•
50 EIKON	99>		•
50 QUADRA	95>96		•
50 QUADRA	97		•
125 EIKON	00		•
150 EIKON	00		•
<b>HONDA</b>			
50 BALI SJ	94>		•
50 SHADOW	98>99		•
50 SHADOW	00>		•
50 SJ BALI	96>02		•
50 SKY	96>		•
50 SKY ANNIVERSARIO	99>00		•
50 SKY CLASSIC	96>		•
50 SKYCLASSIC-VETRO	00>		•
50 SKY DELUXE	99>02		•

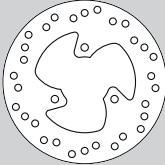
Code			
50 SKY STD		97>02	•
50 SKY VETRO		99>01	•
75 SHADOW		88>	•
90 SHADOW		98>	•
90 YUPI		98	•
90 YUPI		98>	•
100 SJ BALI		95	•
100 SJ BALI		96>	•
110 LEAD		08	•
125 SPACY		96>01	•
<b>MBK</b>			
50 BOOSTER N.G.		01>04	•
50 F1 ASSISTANCE		01	•
50 NITRO		97>	• •
50 STUNT		00>	•
100 NITRO		00>	• •
<b>MOTRON</b>			
50 SPIKE-S		98>	•
50 SYNCRO		99>	•
50 ZR THUNDER		95>	•
<b>PEUGEOT</b>			
50 BLASTER		09>	•
50 BUXY R		93>97	•
50 BUXY RS		93>97	•
50 ELYSEO		97>	•
50 ELYSEO (Pinza AJP)		99>	•
50 ELYSTAR		01>	•
50 JET FORCE/C-TECH		03>	•
50 LOOXOR		02>	•
50 LUDIX CLASSIC/ELEGANCE		03>	•
50 METAL X		01>	•
50 SPEEDAKE		94>97	•
50 SQUAB		94>	•
50 SQUAB (Pinza AJP)		96>	•
50 SV GEO		91	•
50 SV GEO		92	•
50 SV GEO EXECUTIVE		96	•
50 SV ROLAND GARROS		93>	•
50 TKR		96>	•
50 TREEKKER		99>	•
50 TREEKKER STREETBOARD		00>	•
50 TREEKKER URBAN BLACK		00>	•
50 VIVACITY		99>07	•
50 V1VACITY COMPACT		03>	•
50 VIVACITY XRACE		03>	•
80 SV		91>	•
100 LOOXOR		02>	•
100 SV		98>99	•
100 TREKKER		99>	•
100 VIVACITY		99>07	•
125 EXECUTIVE		94>	•
125 LOOXOR		02>	•
125 SV GEO		91>	•
150 ELYSTAR		01>	•
150 LOOXOR		02>	•
<b>RIEJU</b>			
50 CROSSER CR1		96>98	•
50 FIRST		97>99	•
<b>SIAMOTO</b>			
50 MAT		98>	•
50 TOPRACING		98>	•
100 MAT		99>02	•
100 TOP RACING		99>00	•
<b>TGB</b>			
50 202T		99>	•
50 303 R		99>	•
50 309 RS		00>	•
50 AKROS TEC.		94	•
50 HIW'S		99>	•

Code			
50 TRIGGER		99>	•
90 202T		99>	•
90 AKROS		99>	•
90 HIW'S		99>	•
90 TRIGGER		99>	•
125 202 T		99>	•
125 303 R		99>	•
125 309 RS		00>	•
150 303 R		00>	•
150 309 RS		00>	•
<b>YAMAHA</b>			
50 AEROX		97>	• •
50 AEROX REPLICA		97>	• •
50 AEROX ROSSI		04>	• •
50 BW'S NEXT GENERATION		01>	•
50 JOG		01>	•
50 JOGZR		01>	•
50 SLIDER		00>	•
100 AEROX		00>	• •
<b>68B40717</b>			
			
A = 190 B = 58 C = 80 D = 8,5 E = 3,5			
<b>APRILIA</b>			
50 AREA 51		98>00	•
50 AREA 51 SUPERBIKE		00>01	•
50 GULLIVER		95>00	•
50 HABANA		99>	•
50 HABANA CUSTOM		99>	•
50 MCGULLIVER		95>	•
50 MOJITO		04>08	•
50 MOJITO CUSTOM		99>03	•
50 MOJITO RETRO		99>03	•
50 RALLY		92>96	•
50 RALLY		97>	• •
50 RALLY AC		96>	•
50 RALLY LC		92>96	•
50 RALLY LC		97>	• •
50 SCARABEO		98>05	•
50 SCARABEO BRIGHT/DE LUXE		98>	•
50 SCARABEO DITECH		02>04	•
50 SR CAPIROSSI		98	• •
50 SR DITECH		00>03	• •
50 SR EUROPA		93>	•
50 SR LC		94>96	•
50 SR STREET		03>08	•
50 SR R		05>	• •
50 SR R FACTORY		03>04	•
50 SR R FACTORY		05>08	•
50 SR R/R FACTORY		09>	• •
50 SR R/R FACTORY REPLICA SBK		10>	• •
50 SR RACING/STEALTH LC		97>99	• •
50 SR URBAN KID		93>	•
50 SR VIPER-REPLICA		94>	•
50 SR WWW. NETSCAPER		97>01	•
50 VIPER-REPLICA		94>	•
125 HABANA		99>	•
125 HABANA CUSTOM		00>	•
125 HABANA DITECH		02>	•
125 LEONARDO		95>98	•
125 LEONARDO		99>	•
125 LEONARDO ST		03>	•
125 MOJITO		03>08	•
125 MOJITO CUSTOM		99>01	•
125 MOJITO RETRO		99>01	•
125 SR		99>	• •
125 SR REPLICA		99>01	• •
150 LEONARDO		96>98	•
150 MOJITO		03>07	•
150 SR		99>01	• •
150 SR REPLICA		99>	• •



Code			
------	---	---	---

<b>BETA</b>			
50 ARK	99>		•
<b>FANTIC</b>			
50 LEADER	95		•
<b>GILERA</b>			
50 STALKER	98>		•
50 STORM	96>01		•
50 TYPHOON	96		•
50 TYPHOON BENETTON	93>95		•
50 TYPHOON MARTINI	96		•
50 TYPHOON XR	96		•
125 RUNNER	95		•
125 TYPHOON XR	95>		•
<b>KL</b>			
50 HELIOS	98>		•
50 KRYPTON	99>		•
50 XR7	98>		•
125 NOX	00		•
125 PROXY	01>		•
125 PULSAR	00		•
150 NOX	00		•
150 PROXY	01>		•
150 PULSAR	00		•
<b>MBK</b>			
50 NEOS	94>		•
50 OVETTO	96		•
100 OVETTO	00>		•
<b>MONDIAL</b>			
50 XR7	99>		•
<b>PIAGGIO</b>			
50 NRG RST MC2	96>98		•
50 NTT	96		•
50 STORM	94>		•
50 TYPHOON	94>		•
80 TYPHOON	96>		•
125 TYPHOON	96>		•
125 TYPHOON CAT.	02>		•
<b>YAMAHA</b>			
50 NEOS	96		•
50 OVETTO	96>		•
100 NEOS	96		•
100 NEOS	00>		•

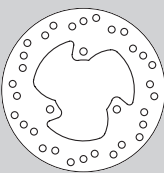

### 68B40719



A = 190 B = 70  
C = 89,5 D = 8,5  
E = 4,5

### APRILIA

50 SR LC	94>96		•
50 SR R FACTORY	03>04		•
50 SR R FACTORY	05>08		•
50 SR STREET	03>08		•
125 ATLANTIC	03>		•
200 ATLANTIC	03>		•
250 ATLANTIC	04>		•
300 ATLANTIC	10>		•
400 ATLANTIC SPRINT	06>		•
500 ATLANTIC SPRINT	05		•

Code			
------	---	---	---

<b>68B40720 HONDA</b>			
50 X8R S/X	98>		•
250 CN	88>		•

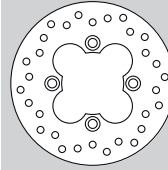

A = 190 B = 72  
C = 94 D = 10,5  
E = 5

### 68B40721

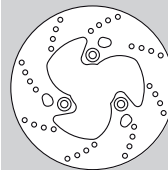

A = 200 B = 58  
C = 80 D = 9  
E = 4

### MALAGUTI

50 CIAK ELECTRONIC POWER	00>01		•
50 F12 PHANTOM DIGIT (all mod.)	03>		•
50 F12 PHANTOM AIR C. REST. E2	06		•
50 F12 PHANTOM CAPIREX	03>		•
50 F12 PHANTOM E1	99>00		•
50 F12 PHANTOM FOGGY	00>		•
50 F12 PHANTOM LC E1	99>00		•
50 F12 PHANTOM LC REST. E1	01>02		•
50 F12 PHANTOM LC REST. E2	02>06		•
50 F12 PHANTOM LC REST. E3	03>04		•
50 F12 PHANTOM REST. E1	01>02		•
50 F12 PHANTOM REST. E2	02		•
50 F12 PHANTOM REST. E3	03>04		•
50 F12 PHANTOM SPECTRUM	00>		•
50 F15 FIRE FOX AIR COOLED	05>06		•
50 F15 FIRE FOX E2	02>03		•
50 F15 FIRE FOX FUN	99>00		•
50 F15 FIRE FOX LC-TDS REST. E1	99>01		•
50 F15 FIRE FOX LC REST. E2	04>05		•
50 F15 FIRE FOX REST. E2	03>04		•
50 F15 FIRE FOX FUN	03>		•
50 F15 FIRE FOX (Twin Disks/Digit Kat)	98>00		•
100 F12 PHANTOM	99>		•

### PEUGEOT

50 VIVACITY 4T	08>		•
----------------	-----	--	---

### 68B40722

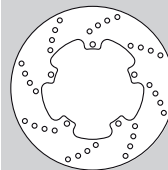

A = 200 B = 96  
C = 107 D = 6,5  
E = 4

### GILERA

50 ICE	99>		•
--------	-----	--	---

### LML ITALIA



150 STAR DE LUXE	09>		•
------------------	-----	--	---

### MALAGUTI

50 DRAKON	05>06		•
-----------	-------	--	---

### PIAGGIO

50 FLY 2T	05>10		•
50 FLY 4T	05>10		•
50 FREE FL	95>02		•
50 SFERA RST	96>98		•
50 VESPA ET2/ET4	97>05		•
50 VESPA LX 2T	05>08		•
50 VESPA LX 2T FL	09>10		•
50 VESPA LX 2T TOURING	10		•
50 VESPA LXV 2T NAVY	08		•
50 VESPA LX 4T-4V	09>10		•
50 VESPA LX 4T-4V TOURING	10		•
50 VESPA S 2T & COLLEGE	07>10		•
50 VESPA S 4T-4V	08>09		•
50 ZIP SP	96>08		•
50 ZIP SP E2	06>09		•
50 ZIP SPORT H2O-SP	96>		•
75 SFERA	96>97		•
100 FLY 4T	08		•
125 HEXAGON GTX	00>		•
125 HEXAGON LX	98>99		•

Code			
------	---	---	---

125 FLY	05>07	•
125 FLY E3	07>08	•
125 SFERA	96>98	•
125 VESPA ET4	96>02	•
125 VESPA LX	04>	•
125 VESPA LX 4T FL	09	•
125 VESPA LX E3 IE	09>10	•
125 VESPA LX TOURING	10	•
125 VESPA LXV 4T NAVY E3	08	•
125 VESPA LXV IE 4T	10	•
125 VESPA PX	96>08	•
125 VESPA PX	98>01	•
125 VESPA PX 30 ANNI	07>08	•
125 VESPA S 4T E3	07>08	•
125 VESPA S 4T IE & COLLEGE	09>10	•
150 FLY	05>07	•
150 FLY E3	08>10	•
150 HEXAGON	98>	•
150 VESPA ET4	99	•
150 VESPA LX E3 IE	09>10	•
150 VESPA LX 4T FL	09	•
150 VESPA LX TOURING	10	•
150 VESPA PX	02>	•
150 VESPA S 4T	08>09	•
150 VESPA S 4T IE & COLLEGE	09>10	•
180 HEXAGON	99>	•
180 SUPERHEXAGON	99>00	• •
200 VESPA PX/PX E	96	•
200 VESPA PX TIME	01	•
250 HEXAGON	98>	•
250 SUPERHEXAGON	99>01	•

### 68B40723

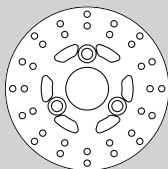

A = 200 B = 98  
C = 110 D = 6,5  
E = 4

#### MALAGUTI

50 CENTRO SL	93>07	•
--------------	-------	---

#### PIAGGIO

50 QUARZT	95	•
50 SKIPPER	92>	•
80 SKIPPER	96	•
125 COMMUTER	93>	•
125 QUARZT	92>	•
125 SKIPPER	93>95	•
150 COMMUTER	93>	•
150 QUARZT	92>	•
150 SKIPPER	94>97	•

### 68B40724

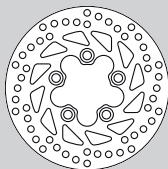

A = 200 B = 58  
C = 80 D = 10,5  
E = 4

#### KYMCO

125 GRAN DINK	02>	•
150 GRAND DINK	02>	•
250 GRAN DINK	00>	•
250 YUP	03>	•

### Code



### 68B40725

#### SUZUKI

250 BURGMAN	03>06	•
400 BURGMAN	03>05	•

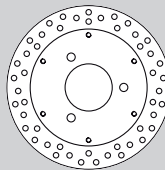

A = 210 B = 60,5  
C = 90 D = 10,5  
E = 5

### 68B40726

#### SUZUKI

400 BURGMAN	06>09	•
-------------	-------	---

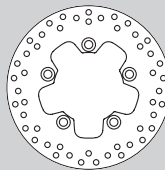

A = 220 B = 88  
C = 110 D = 10,5  
E = 4

### 68B40727

#### SUZUKI

250 BURGMAN	98>02	•
400 BURGMAN	98>02	•

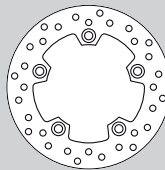

A = 210 B = 109  
C = 132 D = 10,5  
E = 5

### 68B40728

#### SYM

125 HD EVO	07>	•
200 HD EVO	07>	•

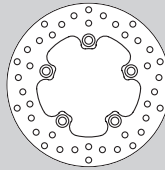

A = 220 B = 97,5  
C = 120 D = 10,5  
E = 4,5

### 68B40729

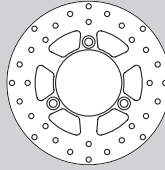

#### SUZUKI

125 SIXTEEN	08>	• •
150 SIXTEEN	08>	• •



A = 220 B = 89  
C = 110 D = 10,5  
E = 4



<b>Code</b>			
-------------	---	---	---

## 68B40730

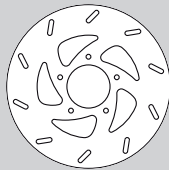

A = 220 B = 58  
C = 80 D = 6,5  
E = 4

### APRILIA

50 SPORTCITY ONE 2T/4T	09>	•
50 SPORTCITY ONE STREET	09>	•

### BETA

125 EIKON	00	•
150 EIKON	00	•

### DERBI

125 PREDATOR	99	•
180 PREDATOR	99	•

### GILERA

50 RUNNER	01>	•
50 RUNNER	94>	•
50 RUNNER DD	96>	•
50 RUNNER PUER JET	03>	•
50 RUNNER RACING REPLICA	03>	•
50 RUNNER SP	00>01	•
125 RUNNER	06>	•
125 RUNNER FX	97>00	•
125 RUNNER FX	01>05	•
125 RUNNER SP	98>	•
125 RUNNER VX	99>04	•
180 RUNNER FXR	98>	•
180 RUNNER FXR SP	99>	•
180 RUNNER SP	98>	•
180 RUNNER VRX	00>	•
180 RUNNER VXR	99>	•
200 HERCULES	02>	•
200 RUNNER SP	01>02	•
200 RUNNER VXR	01>04	•

### KYMCO

50 B&W	01>02	•
125 B&W	00>	•
150 B&W	00>	•

### PIAGGIO

50 CLASSIC SPORT	97>	•
50 NRG EXTREME	99>00	•
50 NRG MC3	01>04	•
50 NRG PUREJET	02>04	•
50 STEALTH	98	•
125 SKIPPER 4T	00>02	•
125 SKIPPER LX	98>99	•
125 SKR	01>02	•
125 STEALTH	96>	•
125 VESPA GRANTURISMO L	01>03	• •
150 SKIPPER LXT - ST	99>	•
150 SKR	01>02	•
150 STEALTH	96>	•
150 VESPA GRANTURISMO L	01>	• •

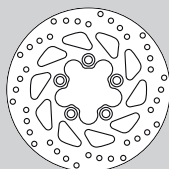

## 68B40731



A = 220 B = 58  
C = 80 D = 10,5  
E = 4

### KYMCO

50 B&W	03>	•
50 DINK	03>07	•
125 DINK CLASSIC	02>	•
125 GRAN DINK	02>	•
125 MOVIE XL	99>	•
150 DINK CLASSIC	02>	•
150 GRAND DINK	02>	•
150 MOVIE XL	01>	•
200 DINK CLASSIC	03>	•
250 B & W	00>	•
250 GRAN DINK	00>	•
250 YUP	03>	•

<b>Code</b>			
-------------	---	---	---

## 68B40732

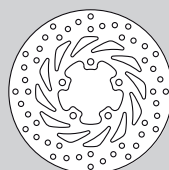

A = 220 B = 60  
C = 80 D = 8,5  
E = 4

### APRILIA

125 LEONARDO	95>98	•
125 LEONARDO	99>	•
150 LEONARDO	96>98	•
150 LEONARDO	99>	• •
200 SCARABEO GT	01>06	•
200 SPORTCITY	04>	•
200 SPORTCITY CUBE	09>	•
250 LEONARDO	99>04	•
300 LEONARDO ST	05>	•
300 SPORTCITY CUBE	08>	•
125 SCARABEO	99>03	•
125 SPORTCITY	06>	•
125 SPORTCITY CUBE	09>	•
150 SCARABEO	99>02	•
250 SPORTCITY	06>08	•

## 68B40733

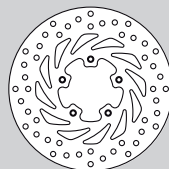

A = 220 B = 60  
C = 80 D = 6  
E = 4

### APRILIA

50 SCARABEO	98>05	•
50 SCARABEO 4T	02>06	•
50 SCARABEO 4T RESTYLING	06>08	•
50 SCARABEO BRIGHT/DE LUXE	98>	•
50 SCARABEO DITECH	02>04	•
50 SCARABEO STREET	98>08	•
100 SCARABEO	99>	•
125 LEONARDO ST	03>	•
125 SCARABEO GT	03>	•

## 68B40735

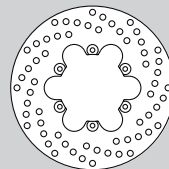

A = 220 B = 90  
C = 101,5 D = 6,25  
E = 4

### MALAGUTI



125 MADISON	99>	•
125 MADISON BLACK RIDER	03>	•

### BENELLI

125 VELVET	99>04	•
125 VELVET TOURING	01>	•
150 VELVET	00>04	•
150 VELVET TOURING	01>	•
250 VELVET	99>	•
250 VELVET TOURING	01>	•
400 VELVET	03>	•

### MALAGUTI

125 F18 PROJECT	00>	•
125 F18 WARRIOR	00>	•
125 MADISON	99>	•
125 MADISON BLACK RIDER	03>	•
125 PHANTOM MAX	03>	• •
150 F 18 PROJECT	00>	•
150 F 18 WARRIOR	00>	•
150 MADISON	99>	• •
180 MADISON	99>	• •
200 MADISON	02>	• •
200 MADISON BLACK RIDER	03>	•
200 PHANTOM MAX	03>	• •
250 MADISON	99>03	•
250 MADISON RS	04>	• •
250 PHANTOM MAX	05>06	• •

Code			
------	---	---	---

### 68B40736

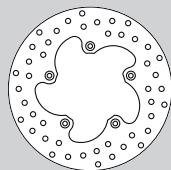

A = 220 B = 96  
C = 115 D = 6,25  
E = 4

#### APRILIA

50	SCARABEO	94>97	•
70	SCARABEO	94>98	•
125	SCARABEO	98	•
150	SCARABEO	98	•
250	LEONARDO	99>04	•
300	LEONARDO ST	05>	•
500	ATLANTIC	01>05	•
500	ATLANTIC SPRINT	06>	•
500	SCARABEO	04>05	•

#### ATALA

50	CAROSSELLO AT 15	97>	•
----	------------------	-----	---

### 68B40737

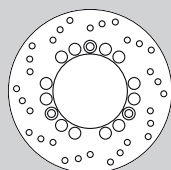

A = 220 B = 100  
C = 120 D = 10,5  
E = 4

#### SUZUKI

125	BURGMAN	01>06	•
150	BURGMAN	01>06	•

### 68B40738

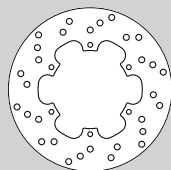



A = 220 B = 105  
C = 120 D = 6,5  
E = 4

#### BETA

50	TEMPO "16"	00>	•
----	------------	-----	---

#### PIAGGIO

50	LIBERTY	97>05	•
50	LIBERTY 2T	06>08	•
50	LIBERTY 2T RST	04	•
50	LIBERTY 2T SPORT	06>08	•
50	LIBERTY 4T	00>08	•
50	LIBERTY 4T RST	04	•
50	LIBERTY 4T DELIVERY TNT	09	•
50	LIBERTY 4T SPORT	06>08	•
50	LIBERTY PTT E2	04>05	•
50	NRG POWER DD	05>10	•
50	NRG POWER DD (Spec. Series)	07>08	•
50	NRG POWER DT	06>08	•
50	NRG POWER PUREJET	04>09	•
50	NRG PUREJET	10	•
100	FREE	02>03	•
125	LIBERTY	98>02	•
125	LIBERTY RST	04>05	•
125	LIBERTY RST PTT	05>06	•
125	LIBERTY SPORT	06	•
125	LIBERTY 4T	06>07	•
125	LIBERTY 4T DELIVERY E3	08	•
125	LIBERTY 4T E3	07>08	•
125	LIBERTY 4T SPORT E3	06>08	•
125	SUPER HEXAGON GTX 12"	01>02	•
125	VESPA GRANTURISMO	03>07	•
125	VESPA GRANTURISMO E3	06>07	•
125	VESPA GT L	04	•
125	VESPA GTV	07>08	•
125	VESPA GTV 4T NAVY E3	08	•
125	VESPA GTS 4T IE SUPER	09	•
125	VESPA GTS E3	07>09	•
125	ZIP 4T	02>	•
150	LIBERTY	00>	•
150	LIBERTY 4T E3	08	•
150	LIBERTY 4T SPORT E3	08	•
150	SUPERHEXAGON	99>	•
180	SUPER HEXAGON GTX 12"	01>02	•
200	LIBERTY	06	•

Code			
------	---	---	---

200	LIBERTY/S	01>	•
200	LIBERTY 4T E3	07>08	•
200	LIBERTY 4T SPORT E3	06>07	•
200	LIBERTY RST	04	•
200	LIBERTY SPORT	06	•
200	VESPA GT L	04>	•
200	VESPA GRANTURISMO	06>07	•
250	HEXAGON	98>	•
250	SUPERHEXAGON	99>01	•
250	VESPA GT 60 E3	06>07	•
250	VESPA GTS, GTS ABS	05>10	•
250	VESPA GTV 4T NAVY E3	08	•
250	VESPA GTV	06>09	•
300	VESPA GTS SUPER	08>09	•
300	VESPA GTS SUPER SPORT	10	•
300	VESPA GTV V. Montenapoleone	10	•

### 68B40739

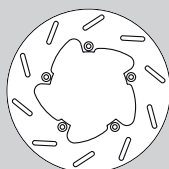

A = 220 B = 105  
C = 120 D = 6,25  
E = 4

#### BENELLI

50	PEPE	99>	•
100	PEPE	99>	•
125	ADIVA	00>	•
125	VELVET	99>04	•
125	VELVET TOURING	01>	•
150	ADIVA	00>	•
150	VELVET	00>04	•
150	VELVET TOURING	01>	•

### 68B40740

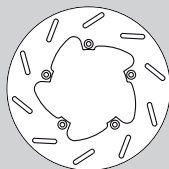

A = 220 B = 105,5  
C = 125 D = 10,5  
E = 4

#### AXY

125	GULP	08>	•
125	YUK	07>	•
150	GULP	08>	•
150	YUK	07>	•
200	GULP	08>	•
200	YUK	07>	•
300	ROAR	08>	•

#### GARELLI

150	MOSQUITO	08>	•
-----	----------	-----	---

#### HONDA

100	CHIOCCIOLA NES	95	•
125	CBR R	03>07	•
125	CHIOCCIOLA @	01>	•
125	DYLAN	00>07	•
125	PS I	06>08	•
125	SH/SH Iniezione	98>08	•
125	VARADERO	01>	•
150	CHIOCCIOLA @	01>06	•
150	DYLAN	00>07	•
150	PS I	06>08	•
150	SH/SH Iniezione	98>08	•
250	XL R BAJA	96	•
250	XR - R	97	•
250	XR - R	98>00	•
250	XR - R	01>	•
400	XR - R	95>05	•
400	XR - R	06>07	•
400	XR - R SUPERMOTARD	00>07	•
440	XR - R	06>07	•
440	XR - R SUPERMOTARD	06>07	•
500	XR	91>93	•
600	XR - R	88>99	•
600	XR R DAKAR	99	•

#### KEEWAY

125	OUTLOOK	08>	•
151	OUTLOOK	08>	•

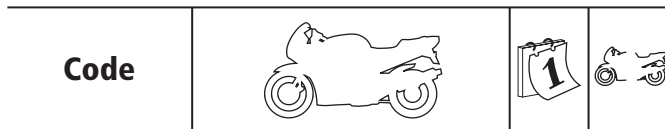

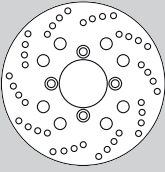
<b>68B40741</b>	<b>SUZUKI</b>			
	125 BURGMAN	01>06		•
	150 BURGMAN	01>06		•
<p>A = 220 B = 64,5 C = 86 D = 10,5 E = 4</p>				

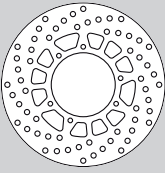
<b>68B40742</b>	<b>YAMAHA</b>			
	600 XT (All Models)	86>89		•
	600 XT - E	90>94		•
<p>A = 220 B = 86 C = 102 D = 6,25 E = 4</p>				

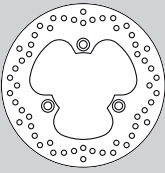
<b>68B40743</b>	<b>HONDA</b>			
	400 CBR RR	89>90		•
	400 NSR	85>88		•
<p>A = 220 B = 88 C = 110 D = 10,5 E = 4,5</p>				

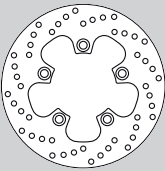
<b>68B40744</b>	<b>SUZUKI</b>			
	600 GSX R	97>03		•
	600 GSX R	04>05		•
<p>A = 220 B = 89 C = 110 D = 10,5 E = 5</p>				

	600 GSX R	06>07		•
	600 GSX R	08>10		•
	650 SV/S	03>09		•
	750 GSX R	85>87		•
	750 GSX R	88>89		•
	750 GSX-R	96>03		•
	750 GSX R	04>05		•
	750 GSX R (Rad. caliper)	06>07		•
	750 GSX R (Rad. caliper)	08>10		•
	1000 GSX R	01>02		•
	1000 GSX R	03>04		•
	1000 GSX R (Rad. caliper)	05>08		•
	1000 GSX R (Rad. caliper)	09>10		•
	1000 SV/S	03>07		•
	1000 TL R	98>03		•
	1000 TL S	97>01		•
	1100 GSX-R	86>88		•

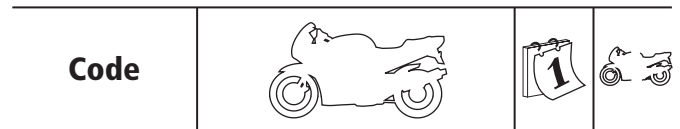

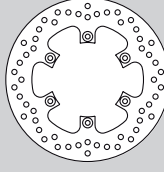
<b>68B40746</b>	<b>KAWASAKI</b>			
	125 KX	88>02		•
	200 KDX	04>06		•
<p>A = 220 B = 100 C = 116 D = 6,5 E = 4,5</p>				

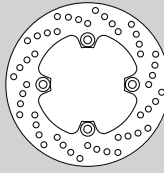

<b>68B40747</b>	<b>KAWASAKI</b>			
	600 ER 6F/ABS	06>		•
	600 ER 6N/ABS	06>		•
<p>A = 220 B = 100 C = 120 D = 10,5 E = 5</p>				

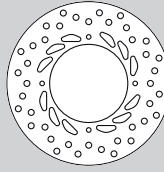
	600 ZX-6R	98>02		•
	600 ZX-6RR	03>04		•
	600 ZX-6RR	05>06		•
	600 ZX-6R	07>09		•
	636 ZX6R 636 NINJA	02		•
	636 ZX6R 636 NINJA	03>04		•
	636 ZX-6R 636 NINJA	05>06		•
	636 ZX 6 RR	03>06		•
	650 ER 6 F	06>08		•
	650 ER 6 F ABS	06>08		•
	650 ER 6 N	06>10		•
	650 ER 6 N ABS	06>10		•
	650 VERSYS	07>08		•
	650 VERSYS ABS	07>08		•
	750 Z 750	04>06		•
	750 Z 750 S	05>06		•
	900 ZX-9R	98>99		•
	900 ZX-9R	00>01		•
	900 ZX-9R	02>03		•
	1000 Z1000	03>06		•
	1000 ZX 10 R	04>07		•
	1000 ZX10R NINJA (Rad. caliper)	08>		•

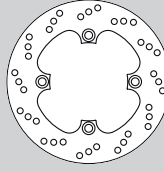
<b>68B40748</b>	<b>HONDA</b>			
	250 XL R BAJA	88>91		•
	650 NX DOMINATOR	93>04		•
<p>A = 220 B = 105 C = 125 D = 6,25 E = 4</p>				

<b>68B40749</b>	<b>HONDA</b>			
	125 PANTHEON FES	03>07		•
	125 S-WING	07>		•
<p>A = 220 B = 105 C = 125 D = 10,5 E = 5</p>				

	150 PANTHEON FES	03>07		•
	150 S-WING	07>		•
	250 FORESIGHT	00>07		•
	250 FORZA	00>04		•
	250 HORNET	97>		•
	250 JAZZ	00>04		•
	250 VTR	98>		•
	250 XELVIS	97>98		•
	400 CB	89>91		•
	400 CB N	82>88		•
	600 CBR F	91>94		•

Code			
------	---	---	---

600	CBR F	95>98	•
600	CBR F	99>00	•
600	CBR F	01>02	•
600	CBR F SPORT	01>02	•
600	CBR F3	03	•
600	CBR F4	01>06	•
600	CBR RR	03>	•
600	CBR RR ABS	09>	•
600	HORNET	98>99	•
600	CB-F HORNET/S	00>06	•
650	FMX	05>06	•
650	NX DOMINATOR	88>92	•
650	XR L	93>08	•
650	XR-R	97>99	•
900	CBR RR	92>93	•
900	CBR RR	94>03	•
929	CBR RR	99>01	•
954	CBR RR	02>03	•
1000	CB R	08>	•
1000	CB R ABS	09>	•
1000	CBR RR	04>05	•
1000	CBR RR	06>07	•
1000	CBR RR	08>	•
1000	CBR RR - ABS	09>	•
1000	VTR F	97>07	•
1000	VTR SP1	00>01	•
1000	VTR SP2	02>04	•

#### PEUGEOT

250	SV	02>	•
-----	----	-----	---

#### TRIUMPH

600	BABY SPEED	01>02	•
600	DAYTONA	03>07	•
600	SPEED FOUR	03>06	•
600	TT	00>03	•
675	DAYTONA TRIPLE	06>09	•
675	SPEED TRIPLE	07>09	•
675	STREET TRIPLE R	07>09	•
855	T 509 SPEED TRIPLE	97>98	•
855	T 509 SPEED TRIPLE	99>	•
900	SPEED TRIPLE T509	97>98	•
900	SPEED TRIPLE	99>	•
950	T 595 DAYTONA	96>98	•
950	T 955 DAYTONA	99>06	•
955	DAYTONA T955i	99>01	•
955	DAYTONA T955i	02>06	•
955	SPEED TRIPLE T955	99>01	•
955	SPEED TRIPLE T955	02>04	•
1050	SPEED TRIPLE S	05>07	•
1050	SPEED TRIPLE S	08>10	•

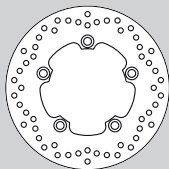

## 68B40750



A = 220 B = 105  
C = 125 D = 10,5  
E = 5

#### YAMAHA

600	YZF R 6	03>04	•
600	YZF R 6	05>	•
1000	YZF R1	04>06	•
1000	YZF R1	07>	•
1000	YZF R1 SP (lim. Edition)	06	•

Code			
------	---	---	---

## 68B40752

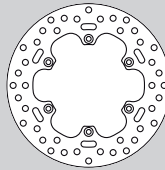

A = 220 B = 110  
C = 125 D = 6,5  
E = 4,2

#### CCM

644	DS	02>06	•
644	R30	02>06	•

#### GAS GAS

125	EC	96>	•
125	MC	96>	•
200	HOBBY	07	•
200	EC	04>07	•
250	EC	96>09	•
250	MC	96>09	•
300	EC	96>09	•
300	MC	96>09	•
400	EC	02	•
400	EC	06>07	•
400	FSE	04>07	•
400	MC	02	•
400	MC	06>07	•
400	PAMPERA	06>07	•
450	EC	03>07	•
450	FSE	03>07	•
450	FSR	07>	•
450	MC	03	•
450	MC	07	•
450	PAMPERA	07>08	•



#### HUSABERG



390	FE	10>	•
400	FE	00>03	•
400	FE E	01>03	•
400	FS C	01>03	•
400	FS E	01>03	•
450	FE	10>	•
450	FS E	03>08	•
450	FX E	10	•
501	FC	99>03	•
501	FE E	99>04	•
501	FE S	99>04	•
550	FC E	01>05	•
550	FE E	04>08	•
570	FE	10>	•
570	FS	10>	•
600	FC	99>03	•
600	FE E	99>02	•
600	FE SUPERMOTARD	99>03	•
650	FE E	01>08	•
650	FE S,C	01>08	•
650	FX E	01>05	•

#### KTM

125	EXC	98>10	•
125	GS	88>92	•
125	GS	93>97	•
125	MX	89>92	•
125	STING	98>	•
125	SX	93>	•
125	SXS	00>	•
144	SX	07>	•
200	EXC	98>	•
200	MXC	98>03	•
200	SX	03>09	•
200	XC W	06>09	•
250	EXC	98>	•
250	EXC-F	04>	•
250	GS	88>92	•
250	GS	93>97	•
250	MX	89>91	•
250	MX	92	•
250	MXC	98>03	•
250	SX	93	•
250	SX	98>	•
250	SX-F	03>	•



Code			
250 SXS		03>	•
250 SXS-F		03>	•
250 XC-F		07>09	•
250 XC-W		06>09	•
300 EXC		97>	•
300 GS		91>96	•
300 MX		91>92	•
300 MXC		98>05	•
300 SX		97>03	•
300 XC		06>09	•
300 XC-W		06>09	•
350 GS 4T		93>	•
380 EXC 2T		98>02	•
380 SX		98>02	•
380 MXC		98>01	•
400 EGS		96>99	•
400 EXC		94>06	•
400 EXC		10	•
400 SX		00>02	•
400 XC-W		07>09	•
450 EXC		03>	•
450 MXC		03>06	•
450 SMR		04>08	•
450 SX F		03>07	•
450 SXS		03>	•
450 SXS-F		03>	•
450 XC		06>09	•
450 XC-F		07>09	•
450 XC-W		07>09	•
500 MX		89>93	•
500 SX		93>95	•
505 SX-F		07>09	•
505 XC-F		07>09	•
520 EXC		00>02	•
520 MXC		01>02	•
520 SX Racing		00>02	•
525 EXC		03>08	•
525 MXC		03>05	•
525 SMR		04>05	•
525 SX		03>06	•
525 XC W		06>08	•
525 XC G		06>08	•
530 EXC		08>	•
540 SXC		98>00	•
540 SXS		01>06	•
560 SMR		06>08	•
600 GS 4T		93>	•
600 LC4		90>93	•
600 MX		90>92	•
620 ADVENTURE		97>98	•
620 DUKE 4T		95>	•
620 DUKE 4T		98>	•
620 EGS-LC4		96>02	•
620 LC4 SC Supercompetition		98>04	•
620 LC4 SXC Supermoto		99>01	•
625 LC4 SC Supercompetition		02	•
625 LC4 SC Supercompetition		03>04	•
625 SMC		05>08	•
625 SXC		03>08	•
640 DUKE II		99>02	•
640 DUKE II		03>06	•
640 LC4 ADVENTURE		98>07	•
640 LC4 ENDURO		98>07	•
640 LC4 Supermoto		98>04	•
640 LC4 Supermoto		05	•
640 LC4 Supermoto		06>	•
660 SMC		03>07	•

Code			
<b>68B40753</b>	<b>APRILIA</b>		
125 EXTREMA		97>	•
125 MX		04>07	•
125 PEGASO		89>94	•
125 RS EXTREMA		89>91	•
125 RS EXTREMA		92>97	•
125 RS REPLICA		92>97	•
125 TUAREG RALLY		89>92	•
600 PEGASO		89>91	•
650 CUBE		93>00	•
650 PEGASO		91>92	•
650 PEGASO		93>00	•

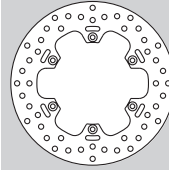

A = 220 B = 110  
C = 124 D = 6,5  
E = 5

<b>68B40754</b>	<b>HUSQVARNA</b>		
125 CR		00>04	•
125 SM		00>	•
125 SM S		03>09	•
125 WR		00>	•
125 WR		00>05	•
125 WR E		00>09	•
250 CR		00>04	•
250 TE		04>10	•
250 WR		00>06	•
360 WR		00>04	•
410 TE		00>01	•
450 SMR		03>05	•
450 TC		02>03	•
450 TE		02>06	•
510 SMR		05	•
510 TC		02>04	•
510 TE		02>04	•
510 TE CENTENNIAL		04>	•
570 SM R		00>	•
570 SM R		01>04	•
570 TC		00>03	•
570 TE		01>04	•
610 TC		00>04	•
610 TE		00>04	•
610 TE E		05>	•
630 SM R		03>05	•

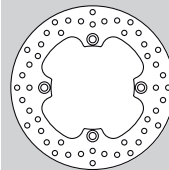

A = 220 B = 112  
C = 130 D = 9,5  
E = 4

<b>68B40755</b>	<b>YAMAHA</b>		
200 DT		89	•
600 YZF R 6		99>02	•
1000 YZF R1		02>03	•

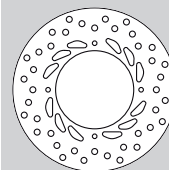

A = 220 B = 115  
C = 133 D = 8,5  
E = 5

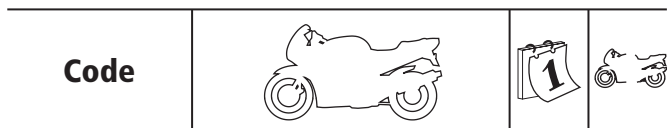

### 68B40756

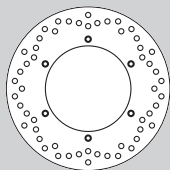

A = 220 B = 115  
C = 133 D = 6  
E = 5

#### HRD

125 GS	97>	•
125 GS - MC	94>96	•
250 GS - MC	94>96	•

#### TM

125 GS - MC	90>92	•
-------------	-------	---

#### YAMAHA

125 DT R	92>03	•
125 TDR	89>99	•
125 WR	89	•
125 WR	90>97	•
125 YZ	85>89	•
125 YZ	90>97	•
200 WR	92>	•
250 TT	>00	•
250 WR	90>91	•
250 WR	92>97	•
250 YZ	85>89	•
250 YZ	90>97	•
360 YZ	89	•
360 YZ	90>93	•
400 WR F	98>00	•
400 YZ F	98>00	•
500 WR	92>93	•
600 TT E	97>00	•
600 TT R	98>00	•
600 TT RE	04>07	•

### Code



### 68B40761

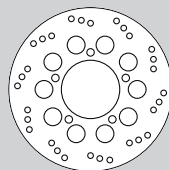

A = 230 B = 82  
C = 104 D = 10,5  
E = 6

#### KAWASAKI

600 ZX-6R	95>97	•
750 ZX-7R	96>02	•
750 ZX 7 R NINJA	99>03	•
750 ZX-7RR	96>	•
1000 GTR	94>06	•

### 68B40762

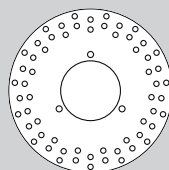

A = 230 B = 84  
C = 102 D = 8,5  
E = 5

#### ITALJET

250 JUPITER	00>	•
-------------	-----	---

#### YAMAHA

250 MAJESTY/ABS	98>99	•
-----------------	-------	---

### 68B40757

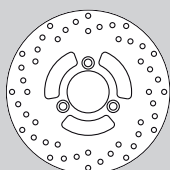

A = 226 B = 58  
C = 80 D = 10,5  
E = 3,5

#### KYMCO

50 PEOPLE	99>02	•
125 PEOPLE	99>	•
150 PEOPLE	99>	•

### 68B40765

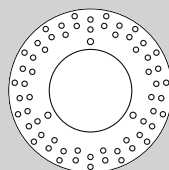

A = 230 B = 116  
C = 136 D = 8,5  
E = 5

#### MBK

250 SKYLINER	00>	•
--------------	-----	---

#### YAMAHA

250 MAJESTY	00>05	•
-------------	-------	---

### 68B40758

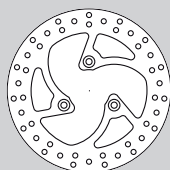

A = 226 B = 58  
C = 80 D = 10,5  
E = 3,5

#### PEUGEOT

50 ELYSTAR	01>	•
50 JET FORCE/C-TECH	03>	•
100 ELYSEO	96>	•
100 ELYSEO	00>	•
100 ELYSEO (Pinza AJP)	98>99	•
125 ELYSEO	00>	•
125 ELYSEO	98>99	•
125 ELYSTAR	01>	•
125 JET FORCE	03>	•
150 ELYSEO	00>	•
150 ELYSTAR	01>	•

### 68B40766

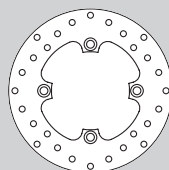

A = 220 B = 105  
C = 125 D = 10,5  
E = 4

#### MALAGUTI

125 CENTRO IE	08>	•
160 CENTRO IE	07>	•

### 68B40767

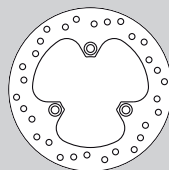



A = 220 B = 88  
C = 11 D = 10,5  
E = 4

#### HONDA

50 HM MOTO	95>	•
50 SH 50 Fifty	96>	•
100 SH FIFTY	96>	•



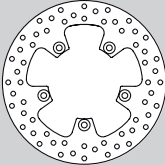

<b>Code</b>			
-------------	---	---	---

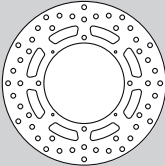
<b>68B40768</b>  A = 240 B = 107 C = 125 D = 8 E = 4	<b>DUCATI</b>		
	749 749/DARK/R/S	03>07	•
	999 999/R/S/XEROX	03>07	•
	1000 DESMOSEDICI RR	08>	•

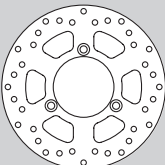
<b>68B40769</b>  A = 240 B = 118 C = 134 D = 6,5 E = 4	<b>HONDA</b>		
	50 CRM	97>02	•
	75 AX 1	89>	•
	75 CRM	95>99	•
	125 CR E	88	•
	125 CR E	92>94	•
	125 CR R	88	•
	125 CR R	92>94	•
	125 CRM	98	•
	125 XLR R	98>00	•
	150 CRF F	03>	•
	230 CRF TRIAL	04>06	•
	230 SL	98	•
	250 CR E	88	•
	250 CR E	92>94	•
	250 CR R	88	•
	250 CR R	92>94	•
	250 CRM R	98	•
	250 NX L	-	•
	250 XL R BAJA	88>91	•
	250 XR-R	97	•
	250 XR-R	98>00	•
	400 XR-R	95>05	•
	500 CR	88	•
	500 CR	92>94	•
	600 XL-R	83>87	•
	600 XR-R	88>99	•
	600 XR R DAKAR	99	•
650 XR-R	00>03	•	

<b>68B40770</b>  A = 240 B = 89 C = 110 D = 10,5 E = 4,5	<b>SUZUKI</b>		
	125 BURGMAN	06>	• •
	200 BURGMAN	07>	• •

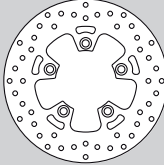

<b>Code</b>			
-------------	---	---	---

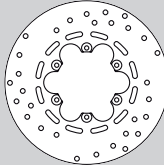
<b>68B40771</b>  A = 240 B = 89 C = 110 D = 10,5 E = 5	<b>KYMCO</b>		
	50 DINK	08>	•
	<b>SUZUKI</b>		
	600 GSF BANDIT	95>99	•
	600 GSF BANDIT	00>04	•
	600 GSF BANDIT S	00>	•
	600 GSX F	98>03	•
	600 GSX F	04>06	•
	600 RF R	93>97	•
	650 GSF BANDIT	05>06	•
	650 SV/S	99>02	•
	750 GSX F	98>03	•
	750 GSX F	04>06	•
	750 GSX R	90>95	•
	900 RF F	94>96	•
	1100 GSX-R	89	•
	1100 GSX-R	90>92	•
	1100 GSX-R W	93>00	•
1200 GSF/S	97>02	•	
1200 GSX	99>01	•	
1200 GSX	02>	•	
1300 GSX-R HAYABUSA	99>07	•	

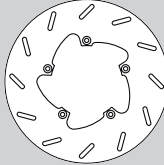
<b>68B40772</b>  A = 240 B = 90 C = 101,5 D = 6,25 E = 4	<b>MALAGUTI</b>		
	250 MADISON	99>03	•
	400 MADISON	02>	•

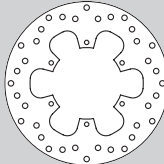
<b>68B40773</b>  A = 240 B = 105 C = 120 D = 6,25 E = 4	<b>APRILIA</b>		
	125 ATLANTIC	03>	•
	125 SCARABEO	04>07	•
	200 ATLANTIC	03>	•
	250 ATLANTIC	04>	•
	300 ATLANTIC	10>	•
	<b>BENELLI</b>		
	250 VELVET	99>	•
	250 VELVET TOURING	01>	•
	400 VELVET	03>	•

<b>68B40774</b>  A = 240 B = 105 C = 120 D = 6,5 E = 4	<b>GILERA</b>		
	125 RUNNER ST	08>	•
	125 RUNNER VX	05>07	•
	200 RUNNER VXR	05>08	•
	500 FUOCO I.E.	07>	•
	<b>PIAGGIO</b>		
	125 MP3	07>08	•
	125 MP3 IE	08>09	•
	125 MP3 HYBRID	09>10	•
	250 MP3	06>08	•
	250 MP3 LT	09	•
	250 MP3 MIC	08>09	•
	300 MP3 IE LT	10	•
	300 MP3 IE MIC	10	•
300 MP3 IE LT HYBRID	10	•	
400 MP3	07>08	•	
400 MP3 LT	09	•	

<b>Code</b>			
-------------	---	---	---

400 MP3 MIC	08>09	•
-------------	-------	---

## 68B40775

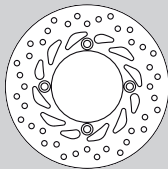

A = 240 B = 125  
C = 140 D = 6,5  
E = 4

### HONDA

125 PANTHEON	98>02	•
125 PANTHEON FES	03>07	•
125 S-WING	07>	•
125 SH ED - Doppio Disco	09>	• •
150 PANTHEON	98>02	•
150 PANTHEON FES	03>07	•
150 S-WING	07>	•
150 SH ED - Doppio Disco	09>	• •
250 CB	91>06	•
250 FORESIGHT	97>99	•
250 FORESIGHT	00>07	•
250 FORZA	00>04	•
250 FORZA X/XE	05>07	•
250 JAZZ	00>04	•

### PEUGEOT

250 SV	02>	•
--------	-----	---

## 68B40776

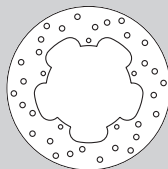

A = 240 B = 125  
C = 140 D = 6,5  
E = 4

### ADIVA

250 ADIVA	06>	•
-----------	-----	---

### GILERA

50 DNA	00>	•
125 DNA	01>	•
125 RUNNER	06>	•
125 RUNNER FX	97>00	•
125 RUNNER FX	01>05	•
125 RUNNER SP	98>	•
125 RUNNER ST	08>	•
125 RUNNER VX	99>04	•
125 RUNNER VX	05>07	•
180 DNA	01>	• •
180 RUNNER FXR	98>	•
180 RUNNER FXR SP	99>	•
180 RUNNER SP	98>	•
180 RUNNER VRX	00>	•
180 RUNNER VXR	99>	•
200 HERCULES	02>	•
200 RUNNER SP	01>02	•
200 RUNNER VXR	01>04	•
200 RUNNER VXR	05>08	•

### ITALJET

125 DRAGSTER	99>01	•
180 DRAGSTER	99>01	•

### PIAGGIO

125 X 7	07>	•
125 X9 EVOLUTION	03	• •
125 X9 EVOLUTION E3	07	• •
125 X9	01>02	• •
150 HEXAGON	98>	• •
180 X9 AMALFI	00>03	• •
200 X9 EVOLUTION	03	• •
200 X9	02>03	• •
200 X9 Amalfi	01>	• •
250 X9	00>	• •
250 X9 EVOLUTION	04	• •
400 X EVO	07>09	•
400 X8 E3	06>08	•

## Code



## 68B40777

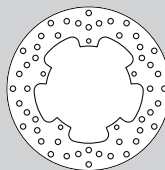

A = 240 B = 125  
C = 140 D = 6,5  
E = 5

### APRILIA

250 SCARABEO	04>05	•
250 SCARABEO I.E.	06>	•
300 SCARABEO SPECIAL/I.E.	09>	•
400 SCARABEO I.E.	06>	•
500 SCARABEO CLASS	10>	•
500 SCARABEO I.E./GT ABS	06>	•

### GILERA

125 NEXUS	07>	•
250 NEXUS	06>	•
500 FUOCO I.E.	07>	•
500 NEXUS	04>	•

### PIAGGIO

125 MP3	07>08	•
125 MP3 IE	08>09	•
125 MP3 HYBRID	09>10	•
125 SUPER HEXAGON GTX 12"	01>02	•
125 X EVO	07	•
125 X7 E3	09	•
125 X7 EVO IE E3	09>10	•
125 X8 PREMIUM E2	06	•
125 X8 PREMIUM E3	06>07	•
125 X8	04>06	•
180 SUPER HEXAGON GTX 12"	01>02	•
200 X8	05>07	•
250 MP3	06>08	•
250 MP3 LT	09	•
250 MP3 MIC	08>09	•
250 X EVO	07	•
250 X7 E3	08	•
250 X8 E3	05>08	•
300 MP3 IE LT	10	•
300 MP3 IE MIC	10	•
300 MP3 IE LT HYBRID	10	•
300 X7 EVO IE E3	09>10	•
400 BEVERLY E3	06>07	•
400 BEVERLY TOURER E3	08>10	•
400 MP3	07>08	•
400 MP3 LT	09	•
400 MP3 MIC	08>09	•
400 X EVO	07>09	•
400 X8 E3	06>08	•
500 BEVERLY	02>06	•
500 BEVERLY CRUISER	07>09	•
500 BEVERLY E3	06>08	•
500 X9	01>02	•
500 X9 EVOLUTION	03>07	•
500 X9 EVOLUTION ABS	06>07	•

## 68B40778

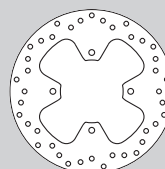

A = 240 B = 92  
C = 114 D = 8,5  
E = 5



### MBK



300 KILIBRE	03>	•
-------------	-----	---



### YAMAHA

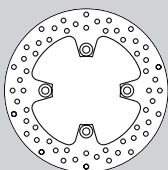

125 X CITY	08>	•
125 X MAX	05>	•
250 X-CITY	07>	•
250 X-MAX	05>	•
300 VERSITY	03>04	•
300 XC Versity	04>06	•

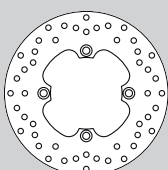



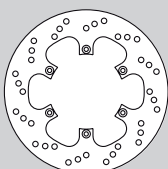

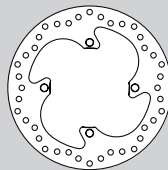

Code			
<b>68B40779</b>  A = 240 B = 102 C = 120 D = 10,5 E = 4,5	<b>KAWASAKI</b>		
	400 ZXR	91>02	•
	550 ZR ZEPHYR	93>01	•
	600 ZZR	93>04	•
	750 GPX R	86>90	•
	750 ZR7/S	99>	•

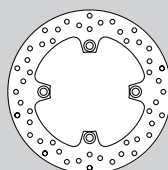

Code			
<b>68B40780</b>  A = 240 B = 105 C = 125 D = 10,5 E = 5	<b>CAGIVA</b>		
	750 ELEFANT	94>95	•
	900 ELEFANT I.E.	90>96	•
	900 GRAN CANYON	99>04	•
	<b>HONDA</b>		
	250 CB	91>06	•
	250 FORZA X/XE	05>07	•
	250 FORZA X/XE	08>	•
	400 SILVER WING	06>08	•
	500 CB	95>03	•
	500 CB S	98>02	•
	600 SILVER WING	00>06	•
	600 SILVER WING	07>	•
	600 SILVER WING ABS	03>	•
	600 XL V TRANSALP	91>93	•
	600 XL V TRANSALP VR/VT	94>96	•
	600 XL V TRANSALP	97>99	•
	650 XL V TRANSALP	00>07	•
	650 XRV AFRICA TWIN	88>89	•
	680 XL 700 V TRANSALP/ABS	08>09	•
750 CB SEVEN-FIFTY	92>95	•	
900 HORNET	02>06	•	



Code			
<b>68B40781</b>  A = 240 B = 110 C = 124 D = 6,5 E = 5	<b>APRILIA</b>		
	650 CUBE	01>	•
	650 PEGASO I.E.	01>04	•
	650 PEGASO STRADA	05>07	•
	650 PEGASO STRADA	08>09	•
	650 PEGASO TRAIL	05>08	•
	<b>BENELLI</b>		
	1100 TNT	04	•
	1130 TNT	05>06	•
	1130 TNT CAFE' RACER	05>07	•
	1130 TNT RS	05>06	•
	1130 TNT SPORT	05>	•
	1130 TNT TITANIUM	05>07	•
	1130 TORNADO TRE	06	•
	1130 TRE-K	06>07	•
	<b>BMW</b>		
	650 F 650	93>01	•
	650 F 650 CS	02>07	•
	650 F 650 DAKAR	00>02	•
	650 F 650 FL	93>00	•
	650 F 650 GS/ABS	00>07	•
	650 F 650 STRADA/ST	97>01	•
	650 G 650 X CHALLENGE/COUNTRY	07>09	•
	650 G 650 X MOTO	07>09	•

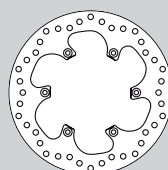

Code			
<b>68B40782</b>  A = 240 B = 116 C = 133 D = 10 E = 4	<b>KAWASAKI</b>		
	125 KX	03>05	•
	125 KX	06>08	•
	250 KX	03>05	•
	250 KX	06>08	•
	250 KX F	04>05	•
	250 KX F	06>10	•
	450 KLX R	06>09	•
	450 KX F	06>10	•
	<b>SUZUKI</b>		
250 RMZ	04>06	•	

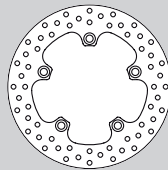
Code			
<b>68B40783</b>  A = 240 B = 116,5 C = 135 D = 10,5 E = 5	<b>HONDA</b>		
	500 CBF	04>08	•
	600 HORNET	07>	•
	600 HORNET ABS/CBS	07>	•
	1000 CBF/ABS	06>08	•

Code			
<b>68B40784</b>  A = 240 B = 118 C = 134 D = 6 E = 4	<b>SUZUKI</b>		
	125 RM	00>06	•
	125 RM	07>08	•
	250 RM	99>08	•
	400 DRZ SM	05>09	•

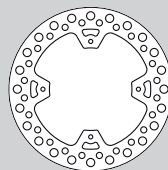
Code			
<b>68B40785</b>  A = 240 B = 120,5 C = 141 D = 10,5 E = 5	<b>SUZUKI</b>		
	400 GSR	06>08	•
	600 GSR	06>	•
	650 GLADIUS	09>	•
	650 GSF BANDIT	07>08	•
	650 GSX F	08>	•
	1250 GSF BANDIT	06>	•

Code			
<b>68B40786</b>  A = 240 B = 121 C = 140 D = 6,25 E = 4	<b>HM MOTO</b>		
	125 CR E SUPERMOTARD	00>01	•
	250 CR E SUPERMOTARD	00>01	•
	450 CRF R	02>	•
	<b>HONDA</b>		
	125 CR E	98>01	•
	125 CR R	98>01	•
	125 CR F SUPERMOTARD	00>05	•
	250 CR E	97>01	•
	250 CR R	97>01	•
	250 CR F SUPERMOTARD	00>05	•
	450 CR F SUPERMOTARD	02>03	•
	450 CR F SUPERMOTARD	04>	•

Code			
------	---	---	---

### 68B40787

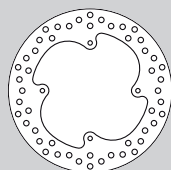

A = 240 B = 121  
C = 140 D = 6  
E = 4

#### HM MOTO

125	CR E SUPERMOTARD	02>03	•
125	CR E SUPERMOTARD	04>08	•
230	CR F ENDURO	04>06	•
230	CR F SUPERMOTARD	04>06	•
250	CR E SUPERMOTARD	02>05	•
250	CR E SUPERMOTARD	06>09	•
250	CRE F	04>09	•
250	CRE X	04>09	•
250	CRF R SUPERMOTARD	04>08	•
250	CRF X SUPERMOTARD	04>08	•
450	CRF R SUPERMOTARD	02>03	•
450	CRF X SUPERMOTARD	04>09	•

#### HONDA

125	CR E	02>08	•
125	CR R	02>08	•
250	CR E	02>08	•
250	CR R	02>08	•
250	CRF R	04>10	•
250	CRF X	04>07	•
250	CRF X	08>09	•
450	CRF R	02>10	•
450	CRF X	04>09	•

### 68B40788

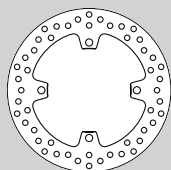

A = 240 B = 122  
C = 140 D = 10  
E = 4

#### SUZUKI

250	RMZ	07>	•
450	RMZ	05>	•

### 68B40789

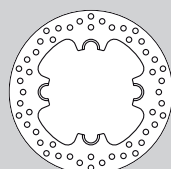



A = 240 B = 127  
C = 130 D = 20  
E = 4

#### BETA

250	RR	05>09	•
400	RR	05>10	•
450	RR	05>10	•
520	RR	10	•
525	RR	05>09	•

#### HUSQVARNA

125	CR	05>10	•
125	WR	09>10	•
250	CR	05>10	•
250	TC	04>10	•
250	WR	07>10	•
450	SMR	06>08	•
450	TC	04>10	•
450	TE	07>10	•
510	SMR	06>08	•
510	TC	05>09	•
510	TE	05>10	•

Code			
------	---	---	---

### 68B40790

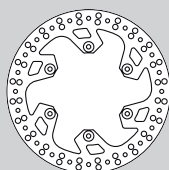

A = 244 B = 115  
C = 133 D = 6,5  
E = 4

#### YAMAHA

125	WR	01>07	•
125	YZ	02>	•
250	WR	01>07	•
250	WR F	01>02	•
250	WR F	03>	•
250	YZ	02>	•
250	YZ F	03>	•
426	WR F	01>02	•
426	YZ F	01>	•
450	WR F	03>	•
450	YZ F	03>	•

### 68B40791

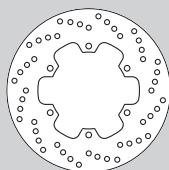







A = 245 B = 115  
C = 133 D = 8,5  
E = 4



#### DUCATI



350	350 SUPERSPORT	91>92	•
400	M400	95>97	•
400	M400	01>06	•
400	M400 DARK	03>	•
400	400 SUPERSPORT	93>97	•
600	M600	93>	•
600	M600/DARK	98	•
600	M600 DARK CITY	99	•
600	M600 MET./DARK/DARK CITY	00>01	•
600	600 SUPERSPORT	91>00	•
620	M620 I.E. DARK SD	04>05	•
620	M620 S I.E.	02>04	•
620	M620 I.E.	05>06	•
620	MULTISTRADA 620 BIDISCO	04>	•
620	MULTISTRADA 620 SD	04>	•
620	SPORT	03>04	•
620	SUPERSPORT	02>05	•
695	MONSTER 695	07	•
696	MONSTER 696 / ABS	08>10	•
750	M750 BIDISCO	96>97	•
750	M750 MONDISCO	96>97	•
750	M750	98>99	•
750	M750/DARK/METALLIC	00>01	•
750	M750 DARK I.E.	02	•
750	750 SPORT	01>02	•
750	750 SUPERSPORT	91>99	•
750	750 SUPERSPORT I.E.	00>02	•
800	M800 S I.E.	03>04	•
800	800 SPORT	03>04	•
800	800 SUPERSPORT/S	03>04	•
800	800 SUPERSPORT	06	•
851	851	89>91	•
851	851 SP 5	93	•
851	851 SP III	91	•
851	851 SP4	92	•
851	851 SP II	90	•
888	888 SP	90>93	•
888	888 SUPERBIKE Strada	94>95	•
900	M900	93>99	•
900	M900 I.E.	00	•
900	M900 CROMO	98	•
900	M900 CROMO I.E.	00>01	•
900	M900 DARK CITY	99	•
900	M900 DARK I.E.	00>02	•
900	M900 METALLIC I.E.	00>01	•
900	M900 S I.E.	00>01	•
900	M900 SPECIAL	98	•
900	SL SUPERLIGHT	92	•
900	SL SUPERLIGHT	93>97	•
900	SPORT	02	•
900	900 SS	89>90	•
900	900 SS	91>99	•
900	900 SS I.E.	00>02	•
900	900 SS S I.E.	02	•

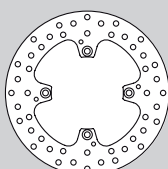



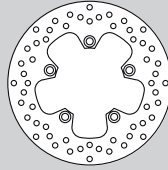

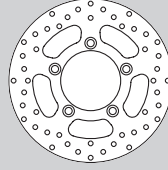

Code			
907 907 i.e.		90>91	•
907 907 i.e.		92>93	•
916 M S4		01	•
916 M S4		02>03	•
916 M S4 FOGGY		02>	•
916 ST4		99	•
916 ST4		00>04	•
916 ST4 S		03>	•
944 ST2		97>99	•
944 ST2		00>03	•
996 ST4 S		01>05	•
1000 GT		06>	•
1000 M1000 S I.E.		03>	•
1000 MS2R		03>05	•
1000 PAUL SMART I.E.		06>07	•
1000 1000SS S		03>	•
1000 1100SS		03>06	•
1000 SPORT		06>07	•
1000 SPORT S		07>	•
1000 ST3		04>06	•
<b>ITALJET</b>			
250 JUPITER		00>	•
<b>LAVERDA</b>			
650 GHOST		96>99	•
650 SPORT		95>01	•
668 DIAMANTE		96>98	•
668 STRIKE		97>99	•
750 BLACK STRIKE		00>	•
750 FORMULA		97>98	•
750 FORMULA		99>01	•
750 SPORT		97>98	•
750 STRIKE		98>01	•
750 SUPER SPORT		99>00	•
800 T-8		98	•
800 TSS		98	•
<b>MBK</b>			
250 SKYLINER		00>	•
<b>MOTOR UNION</b>			
125 MAXI		99>	•
150 MAXI		99>	•
400 MAXI		99>	•
<b>YAMAHA</b>			
50 TZR		93>02	•
150 TEO'S		03	•
250 MAJESTY		96>97	•
250 MAJESTY/ABS		98>99	•
250 MAJESTY		00>05	•
400 SRX		91>	•
400 XJR		95>00	•
600 XJ N		98>03	•
750 SUPERTENERE'		89>	•
1000 YZF R1		98>01	•

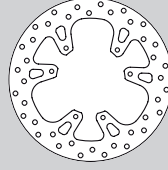

Code			
<b>68B40792</b>			
			
A = 245 B = 108,3 C = 125 D = 8,5 E = 5			
<b>DUCATI</b>			
796 MONSTER		10>	•
796 HYPERMOTARD		10>	•
800 MS2R/DARK		05>06	•
848 848		08>	•
1000 MS2R		06>07	•
1000 MS2R DARK		06>07	•
1000 MS4R		03>04	•
1000 MS4R (monobraccio)		05>06	•
1000 MS4RS		06>	•
1000 MULTISTRADA/S		03>06	•
1100 HYPERMOTARD/S/EVO/SP		07>	•
1100 M1100		09>	•
1100 M1100 S		09>	•
1100 MULTISTRADA/S		07>09	•

Code			
<b>68B40793</b>			
			
A = 245 B = 105 C = 125 D = 8,5 E = 5			
<b>YAMAHA</b>			
600 DIVERSION		09>	•
600 FZ6-FAZER		04>08	•
600 FZ6 S2-FAZER		07>08	•
600 FZS FAZER		04>08	•
600 XJ 6		09>10	•
660 MT-03		06>08	•
1000 FZ1		06>	•
1000 FZ1 S FAZER		06>10	•
1000 FZ1-S FAZER		06>	•

Code			
<b>68B40795</b>			
			
A = 240 B = 88 C = 110 D = 10,5 E = 4			
<b>KYMCO</b>			
125 AGILITY R 16"		08>	•
150 AGILITY R 16"		08>	•

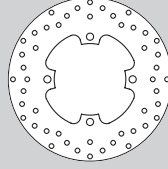
Code			
<b>68B40796</b>			
			
A = 240 B = 101 C = 117 D = 6,25 E = 3			
<b>HM MOTO</b>			
250 CRE F		04>09	•
250 CRE X		04>09	•
450 CRF R		02>	•
<b>HONDA</b>			
125 CR E		95>97	•
125 CR E		98>01	•
125 CR E		02>08	•
125 CR R		95>97	•
125 CR R		98>01	•
125 CR R		02>08	•
230 CRF ENDURO		04>06	•
250 CR E		95>96	•
250 CR E		97>01	•
250 CR E		02>08	•
250 CR R		95>96	•
250 CR R		97>01	•
250 CR R		02>08	•
250 CRF R		04>10	•
250 CRF X		04>07	•
450 CRF R		02>10	•
450 CRF X		04>09	•
500 CR E		95>01	•
500 CR R		95>01	•

Code			
<b>68B40797</b>			
			
A = 240 B = 105 C = 125 D = 10,5 E = 6			
<b>HONDA</b>			
400SW - T 400		09>	•

<b>Code</b>			
-------------	---	---	---

### 68B40798

#### MALAGUTI

250	PASSWORD CK 250	05>	•
-----	-----------------	-----	---

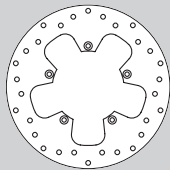

A = 240 B = 105  
C = 120 D = 6,25  
E = 4

### 68B40799

#### KYMCO

250	XCITING	05>	•
250	XCITING	05>	•
300	XCITING/R	08>	•
500	XCITING	04>	•
500	XCITING R	07>	•

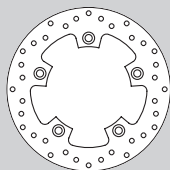

A = 240 B = 125  
C = 150 D = 10,5  
E = 5

### 68B407A0

#### SUZUKI

600	GSX F	89>97	•
650	DL V-STROM	04>06	•
650	DL V-STROM	07>	•
750	GSX F-FL SLINGSHOT	89>92	•

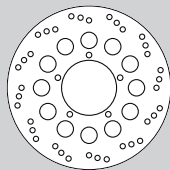

A = 250 B = 84  
C = 100 D = 8,5  
E = 6

### 68B407A1

#### SUZUKI

650	BURGMAN	02>03	•
-----	---------	-------	---

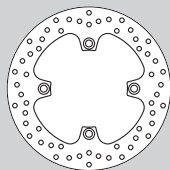

A = 250 B = 117,5  
C = 138 D = 10,5  
E = 5



### 68B407A2

#### SUZUKI

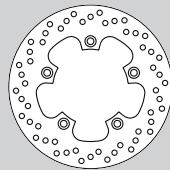
650	BURGMAN	04>09	•
-----	---------	-------	---



A = 250 B = 118  
C = 138 D = 10,5  
E = 5,9

<b>Code</b>			
-------------	---	---	---

### 68B407A3

#### KAWASAKI

750	Z 750	07>10	•
1000	Z1000	07>	•
1000	Z1000/ABS	07>09	•
1400	GTR	07>	•
1400	ZZR	06>	•

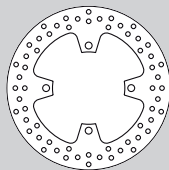

A = 250 B = 110  
C = 130 D = 10,5  
E = 5

### 68B407A4

#### TRIUMPH

955	SPRINT RS	00>04	•
955	SPRINT ST	98>04	•
1050	SPRINT ST	05>08	•
1050	TIGER/ABS	07>08	•

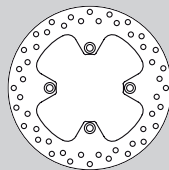

A = 255 B = 105  
C = 125 D = 10,5  
E = 5

### 68B407A5

#### HONDA

350	CB S-G	87>	•
450	CB S	85>89	•
600	XL V TRANSALP	97>99	•
650	NX DOMINATOR	88>92	•
650	NX DOMINATOR	93>04	•
650	XL V TRANSALP	00>07	•
650	XR L	93>08	•
680	XL 700 V TRANSALP/ABS	08>09	•

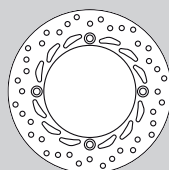

A = 256 B = 144  
C = 166 D = 10,5  
E = 4

### 68B407A6



#### HONDA

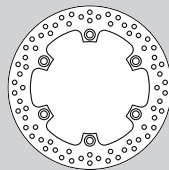

250	FORZA X/XE	08>	•
300	SH 300 I.	06>09	• •
400	NSR	85>88	•
400	SILVER WING	06>08	•
500	VF F-F2	83>87	• •
600	SILVER WING	00>06	•
750	VFR F	85>87	•
750	VFR F	88>89	•
750	XRV AFRICA TWIN	90>02	•
1000	CBR F	93>97	•
1000	XL-V VARADERO	99>	•
1100	CBR XX	97>04	•
1100	CB X 11	00>03	•
1300	CB	03>	•





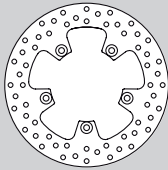

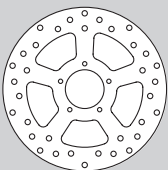

A = 256 B = 144  
C = 166 D = 10,5  
E = 5

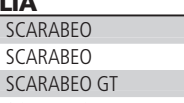

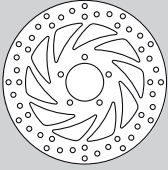
2



Code			
<b>68B407A8</b>	<b>PEUGEOT</b>		
	125 SATELIS ABS	06>08	•
	250 GEOPOLIS	06>	•
	400 GEOPOLIS	07>	•
	400 SATELIS	07>	•
	400 SAT RS	07>	•
	500 SATELIS	06>	•
	500 SAT RS	07>	•
A = 240 B = 126 C = 140 D = 6,25 E = 6			

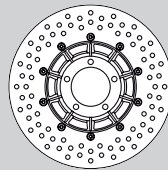

Code			
<b>68B407A9</b>	<b>MALAGUTI</b>		
	125 CENTRO IE	08>	•
	160 CENTRO IE	07>	•
A = 245 B = 58 C = 76 D = 6,5 E = 4			

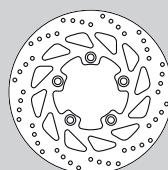

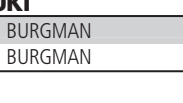
Code			
<b>68B407B0</b>	<b>APRILIA</b>		
	125 SCARABEO	99>03	•
	125 SCARABEO	04>07	•
	125 SCARABEO GT	03>	•
	125 SCARABEO I.E.	08>	•
	125 SPORTCITY	05>	•
	125 SPORTCITY	06>	•
	125 SPORTCITY CUBE	09>	•
	150 SCARABEO	99>02	•
	200 SCARABEO GT	01>06	•
	200 SCARABEO LIGHT/I.E.	07>	•
	200 SPORTCITY	04>	•
	200 SPORTCITY CUBE	09>	•
	250 SCARABEO	04>05	•
	250 SCARABEO I.E.	06>	•
	250 SPORTCITY	06>08	•
	300 SCARABEO SPECIAL/I.E.	09>	•
	300 SPORTCITY CUBE	08>	•
	400 ATLANTIC SPRINT	06>	•
	400 SCARABEO I.E.	06>	•
	400 SCARABEO LIGHT	07>	•
	500 ATLANTIC	01>05	•
	500 ATLANTIC SPRINT	05	•
	500 ATLANTIC SPRINT	06>	•
	500 SCARABEO	04>05	•
	500 SCARABEO CLASS	10>	•
	500 SCARABEO I.E./GT ABS	06>	•
	500 SCARABEO LIGHT	07>	•
	<b>DERBI</b>		
	125 RAMBLA	09>	•
	250 RAMBLA	09>	•
A = 260 B = 60 C = 80 D = 8,5 E = 4			

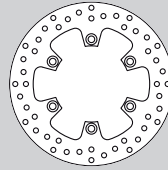

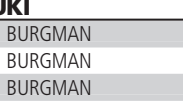
Code			
<b>68B407B1</b>	<b>BMW</b>		
	- SERIE R all model (pinza ATE)	76>80	•
	- SERIE R all model (pinza BB)	81>84	•
	1000 R 100	76>83	•
	1000 R 100 CS	76>80	•
A = 260 B = 62 C = 79 D = 8,5 E = 5			

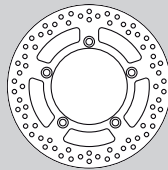
Code			
<b>68B407B2</b>	<b>KYMCO</b>		
	50 AGILITY R 16"	08>	•
	50 PEOPLE S	05>	•
	125 AGILITY R 16"	08>	•
	125 PEOPLE S	05>06	•
	125 PEOPLE S	07>	• •
	150 AGILITY R 16"	08>	•
	200 PEOPLE S	05>06	•
	200 PEOPLE S	07>	• •
	250 PEOPLE S	02>05	• •
	250 PEOPLE S	06>	• •
	300 PEOPLE S	08>	• •
A = 260 B = 88 C = 110 D = 10,5 E = 4			

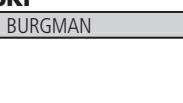
Code			
<b>68B407B3</b>	<b>SUZUKI</b>		
	250 BURGMAN	98>02	•
	400 BURGMAN	98>02	•
A = 260 B = 121 C = 142 D = 10,5 E = 4,5			

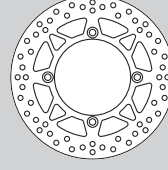
Code			
<b>68B407B4</b>	<b>SUZUKI</b>		
	250 BURGMAN	03>06	•
	400 BURGMAN	03>05	•
	400 BURGMAN	06>09	•
	650 BURGMAN	04>09	•
A = 260 B = 121 C = 142 D = 10,5 E = 4,5			

Code			
<b>68B407B5</b>	<b>SUZUKI</b>		
	650 BURGMAN	02>03	•
A = 260 B = 121 C = 142 D = 10,5 E = 4,5			

Code			
------	---	---	---

### 68B407B6

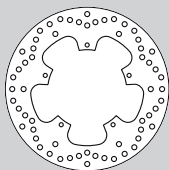

A = 260 B = 125  
C = 140 D = 6,5  
E = 4

#### ADIVA

250 ADIVA	06>	•
-----------	-----	---

#### GILERA

125 NEXUS	07>	•
250 NEXUS	06>	•
500 NEXUS	04>	•

#### PIAGGIO

125 X EVO	07	•
125 X 7	07>	•
125 X7 E3	09	•
125 X7 EVO IE E3	09>10	•
125 X8 PREMIUM E2	06	•
125 X8 PREMIUM E3	06>07	•
125 X8	04>06	•
200 BEVERLY	03>	• •
200 X8	05>07	•
250 X EVO	07	•
250 X7 E3	08	•
250 X8 E3	05>08	•
300 CARNABY CRUISER	09>10	•
300 X7 EVO IE E3	09>10	•
400 BEVERLY E3	06>07	•
400 BEVERLY TOURER E3	08>10	•
500 BEVERLY CRUISER	07>09	•
500 X9 EVOLUTION	03>07	•
500 X9 EVOLUTION ABS	06>07	•

### 68B407B7

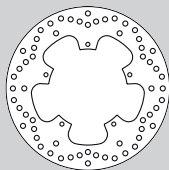

A = 260 B = 125  
C = 140 D = 6,5  
E = 5

#### PIAGGIO

125 BEVERLY	01>03	• •
125 BEVERLY E3 MIC	07	• •
125 BEVERLY E3 SPORT	07>08	• •
125 BEVERLY E3	07>08	• •
125 BEVERLY RST	04>07	• •
125 BEVERLY TOURER E3	08>10	• •
125 CARNABY	07>10	• •
200 CARNABY	07>08	• •
250 BEVERLY E3 MIC	07	• •
250 BEVERLY RST	04>05	• •
250 BEVERLY SPORT	06>08	• •
250 BEVERLY CRUISER	07>09	• •
250 BEVERLY IE E3	06>08	• •
250 BEVERLY TOURER E3	08>09	• •
250 BEVERLY	06>07	• •
250 CARNABY	08	• •
300 BEVERLY TOURER E3	09>10	• •
300 CARNABY CRUISER	09>10	•
500 BEVERLY	02>06	•
500 BEVERLY EURO3	06>08	•
500 X9	01>02	•

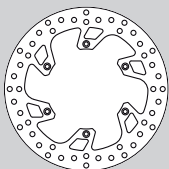

### 68B407B8



A = 260 B = 127  
C = 143 D = 6,5  
E = 3,7

#### HUSABERG

390 FE	10>	•
400 FE	00>03	•
400 FE E	01>03	•
400 FS C	01>03	•
400 FS E	01>03	•
450 FE	10>	•
450 FX E	10	•
470 FC E	01>02	•
501 CR	99>03	•
501 FC	99>03	•
501 FE E	99>04	•
501 FE S	99>04	•
550 FC E	01>05	•
550 FE E	04>08	•
570 FE	10>	•
600 FC	99>03	•



Code			
------	---	---	---

600 FE E	99>02	•
650 FE E	01>08	•
650 FX E	01>05	•

#### KTM

125 EXC	98>10	•
125 GS	93>97	•
125 MX	89>92	•
125 SX	93>	•
125 SXS	00>	•
144 SX	07>	•
200 EXC	98>	•
200 MXC	98>03	•
200 SX	03>09	•
200 XC W	06>09	•
250 EXC	98>	•
250 EXC-F	03	•
250 EXC-F	04>	•
250 GS	93>97	•
250 MX	92	•
250 MXC	98>03	•
250 SX	93	•
250 SX	98>	•
250 SX-F	03>	•
250 SXS	03>	•
250 SXS-F	03>	•
250 XC-F	07>09	•
250 XC-W	06>09	•
300 EXC	97>	•
300 GS	91>96	•
300 MX	91>92	•
300 MXC	98>05	•
300 SX	93	•
300 SX	97>03	•
300 XC	06>09	•
300 XC-W	06>09	•
350 GS 4T	93>	•
380 EXC 2T	98>02	•
380 SX	98>02	•
380 MXC	98>01	•
400 EGS	96>99	•
400 EXC	94>06	•
400 EXC	10	•
400 SX	00>02	•
400 XC-W	07>09	•
450 EXC	03>	•
450 MXC	03>06	•
450 SX F	03>07	•
450 SXS	03>	•
450 SXS-F	03>	•
450 XC	06>09	•
450 XC-F	07>09	•
450 XC-W	07>09	•
500 MX	89>93	•
500 SX	93>95	•
505 SX-F	07>09	•
505 XC-F	07>09	•
520 EXC	00>02	•
520 MXC	01>02	•
520 SX Racing	00>02	•
525 EXC	03>08	•
525 MXC	03>05	•
525 SX	03>06	•
525 XC W	06>08	•
525 XC G	06>08	•
530 EXC	08>	•
540 SXC	98>00	•
540 SXS	01>06	•
600 GS 4T	93>	•
600 LC4	90>93	•

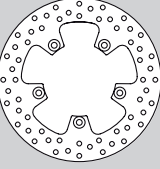

Code			
600 MX		90>92	•
620 LC4 SC Supercompetition		98>04	•
620 LC4 SXC Supermoto		99>01	•
625 LC4 SC Supercompetition		02	•
625 SXC		03>08	•

<b>68B407C0</b>	<b>BMW</b>		
	650 F 650 GS/ABS	08>	•
	800 F 800 GS	09>	•
	800 F 800 R	09>	•
	800 F 800 S	06>07	•
	800 F 800 S	08>09	•
	800 F 800 ST	06>07	•
	800 F 800 ST	08>09	•
	1200 HP2 ENDURO	06>09	•
	1200 HP2 MEGAMOTO	07>09	•
	1200 HP2 SPORT	08>09	•
	1200 K 1200 R	05>08	•
	1200 K 1200 R SPORT	07>	•
	1200 K 1200 S/ABS	05>07	•
	1200 R 1200 GS/ABS	04>09	•
	1200 R 1200 GS ADVENTURE	06>09	•
	1200 R 1200 R	06>09	•
	1200 R 1200 RT	05>09	•
	1200 R 1200 S	06>07	•
1200 R 1200 S	08>	•	
1200 R 1200 ST	05>08	•	
1300 K 1300 R/ABS	09>	•	
1300 K 1300 S	09>	•	

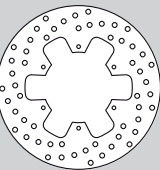

A = 265 B = 136,5  
C = 160 D = 10,5  
E = 5

<b>68B407C1</b>	<b>YAMAHA</b>		
	600 TT E	97>00	•
	600 TT R	98>00	•
	600 TT RE	04>07	•

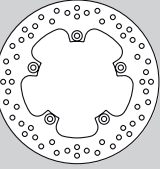
A = 267 B = 115  
C = 133 D = 6,25  
E = 4

<b>68B407C2</b>	<b>YAMAHA</b>		
	125 X MAX	05>	•
	250 X-MAX	05>	•
	400 MAJESTY	04	•
	400 MAJESTY	05>07	•

A = 267 B = 132  
C = 150 D = 8,5  
E = 5

Code			
------	---	---	---

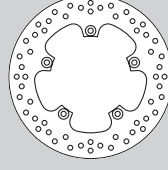
<b>68B407C3</b>	<b>YAMAHA</b>		
	400 MAJESTY	08>	•

A = 267 B = 132  
C = 150 D = 8,5  
E = 4

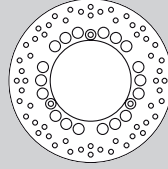
<b>68B407C4</b>	<b>YAMAHA</b>		
	400 MAJESTY	04	•
	400 MAJESTY	05>07	•
	400 MAJESTY	08>	•

A = 267 B = 132  
C = 150 D = 8,5  
E = 5

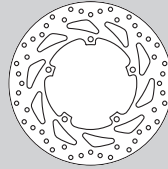
<b>68B407C5</b>	<b>MBK</b>		
	300 KILIBRE	03>	•
	<b>YAMAHA</b>		
	300 VERSITY	03>04	•
	300 XC Versity	04>06	•

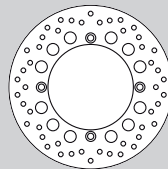

A = 270 B = 128  
C = 146 D = 8,5  
E = 5

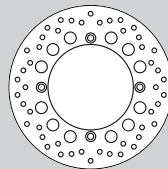

<b>68B407C7</b>	<b>HONDA</b>		
	750 XRV AFRICA TWIN	90>02	•

A = 276 B = 144  
C = 166 D = 10,5  
E = 4

<b>68B407C8</b>	<b>BMW</b>		
	850 R 850 C	98>01	•
	850 R 850 GS	98>07	•
	850 R 850 R	94>01	•
	850 R 850 R	02>07	•
	850 R 850 R, ROADSTER	95>00	•
	850 R 850 RT ABS	95>01	•
	850 R 850 RT	02>04	•
	1000 R 100 R	91>96	•
	1100 R 1100 GS	94>01	•
	1100 R 1100 R	95>01	•
	1100 R 1100 R ROADSTER	95>00	•
	1100 R 1100 RS	85>95	•

A = 276 B = 198  
C = D = 10,5  
E = 5

Code			
1100 R 1100 RT		96>01	•
1100 R 1100 S		98>00	•
1100 R 1100 S		01>06	•
1100 R 1100 S BOXER		03>06	•
1150 R 1150 GS		99>04	•
1150 R 1150 GS ADVENTURE		02>05	•
1150 R 1150 R		01>06	•
1150 R 1150 ROCKSTER		03>06	•
1150 R 1150 RS		01>05	•
1150 R 1150 RT		01>05	•

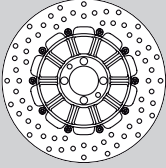
Code			
<b>68B407D3</b>		<b>BMW</b>	
		750 K 75 (NO ABS)	84>96 •
		750 K 75 RT	90>96 •
		750 K 75 S	85>88 •
		1000 K 1	89>93 •
		1000 K 100 (NO ABS)	83>89 •
		1000 K 100 LT ABS	90>91 •
		1000 K 100 RS	83>91 •
		1000 K 100 RS 16 V	89>93 •
		1000 K 100 RT	84>89 •
		1100 K 1100 LT	91>99 •

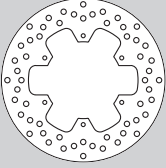
<b>68B407C9</b>	<b>YAMAHA</b>		
	500 RD LC	84>88	•
	600 FZR	89	•
	600 FZR	90>95	•
	600 FZS FAZER	98>00	•
	600 FZS FAZER	01>03	•
	600 SRX rightside	86>	•
	600 XJ DIVERSION	91>97	•
	600 XJ DIVERSION	98>03	•
	600 YZF R THUNDER CAT	96>02	•
	660 XT R	04>10	•
	660 XT X	04>09	•
	660 XTZ TENERE'	08>	•
	750 SUPERTENERE'	89>	•
	750 YZF R/SP	93>97	•
	750 YZF R7	99>01	•
	800 FZS FAZER	98>99	•
	850 TDM	91>01	•
	850 TRX	95>00	•
	900 TDM	02>	•
	1000 YZF R THUNDER ACE	96>98	•

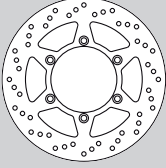

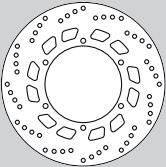
<b>68B407D5</b>	<b>SUZUKI</b>		
	650 DR R-RS	92>93	•
	650 DR RSE	91>95	•
	650 FREEWIND	97>	•
	800 DR BIG	91>95	•

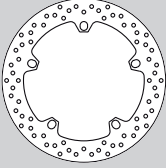
<b>68B407D0</b>	<b>YAMAHA</b>		
	125 XV S DRAG STAR	01>02	•
	125 XV S VIRAGO	97>00	•
	125 XV VIRAGO	97>00	•
	250 XV S VIRAGO	97>00	•
	500 T-MAX	01>03	•
	600 XT - E	95>	•
	660 XTZ TENERE'	91>96	•
	750 XV VIRAGO	94>00	•
	1300 FJR A	06>	•
	1300 FJR AS	06>	•

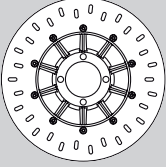
<b>68B407D6</b>	<b>BMW</b>		
	800 F 800 S	06>07	•
	800 F 800 ST	06>07	•
	850 R 850 C	98>01	•
	850 R 850 GS	98>07	•
	850 R 850 R	02>07	•
	1100 R 1100 GS	94>01	•
	1100 R 1100 S	98>00	•
	1150 R 1150 GS	99>04	•
	1150 R 1150 GS ADVENTURE	02>05	•
	1200 HP2 ENDURO	06>09	•
	1200 K 1200 LT	99>01	•
	1200 K 1200 RS	97>00	•
	1200 R 1200 CRUISER	97>01	•
	1200 R 1200 C CLASSIC	03>	•
	1200 R 1200 CL	02>06	•
	1200 R 1200 GS/ABS	04>09	•
	1200 R 1200 GS ADVENTURE	06>09	•
	1200 R 1200 S	06>07	•

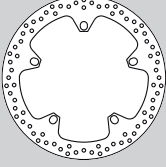
<b>68B407D2</b>	<b>BMW</b>		
	650 R 65 RT	85>95	•
	750 K 75 (NO ABS)	84>96	•
	750 K 75 C	85>91	•
	750 K 75 RT	90>96	•
	750 K 75 S	85>88	•
	750 K 75 S	89>92	•
	750 K 75 S	93>96	•
	800 R 80	81>95	•
	800 R 80 R	91>95	•
	800 R 80 RT	83>95	•
	1000 K 100 (NO ABS)	83>89	•
	1000 K 100 LT ABS	90>91	•
	1000 K 100 RS	83>91	•
	1000 K 100 RT	84>89	•
	1000 R 100 GS	87>95	•
	1000 R 100 PD	91>95	•

<b>68B407D7</b>	<b>BMW</b>		
	800 F 800 R	09>	•
	800 F 800 S	08>09	•
	800 F 800 ST	08>09	•
	850 R 850 RT	02>04	•
	1100 R 1100 S	01>06	•
	1100 R 1100 S BOXER	03>06	•
	1150 R 1150 R	01>06	•
	1150 R 1150 ROCKSTER	03>06	•
	1150 R 1150 RS	01>05	•
	1150 R 1150 RT	01>05	•
	1200 HP2 MEGAMOTO	07>09	•
	1200 HP2 SPORT	08>09	•
	1200 K 1200 GT	02>	•
	1200 K 1200 LT	02>	•
	1200 K 1200 R	05>08	•
	1200 K 1200 R SPORT	07>	•
	1200 K 1200 RS	01>	•
	1200 K 1200 S / ABS	05>07	•
	1200 R 1200 R	06>09	•

Code			
------	---	---	---

1200 R 1200 RT	05>09	•
1200 R 1200 S	08>	•
1200 R 1200 ST	05>08	•
1300 K 1300 GT	09>	•
1300 K 1300 R/ABS	09>	•
1300 K 1300 S	09>	•

### 68B407D9 PEUGEOT

125 GEO RS	08>	•
125 SATELIS ABS	06>08	•
250 GEOPOLIS	06>	•
250 GEO RS	08>	•
400 GEOPOLIS	07>	•
400 GEO RS	08>	•
500 GEOPOLIS	08>	•

A = 260 B = 101  
C = 120 D = 8,25  
E = 5

### 68B407E0 HARLEY DAVIDSON



883 XLH 883	70>84	•
1000 XL 1000	78>81	•
1000 XLS 1000 ROAD STER	79>84	•
1340 FLH 1340 80	81>84	•
1340 FLH 1340 81	87>99	•
1340 FLH 1340 82	87>99	•
1340 FLH 1340 83	89>99	•
1340 FLSTC 1340 HERITAGE SOFTAIL CLAS.	89>99	•
1340 FLSTC FAT BOY	89>99	•
1340 FXDWG DYNA WIDE GLIDE	93>98	•
1340 FXR 1340 SUPER GLIDE	82>99	•
1340 FXRL 1340 LOW RIDER CUSTOM	87>99	•
1340 FXRS 1340 LOW RIDER SPORT	87>99	•
1340 FXRS LOW RIDER SPORT EDITION	87>99	•
1340 FXRT 1340 SPORT GLIDE	87>99	•
1340 FXSTC 1340 SOFTAIL CUSTOM	89>99	•
1340 FXSTS 1340 SPRINGER SOFTAIL	89>99	•
1450 FLHR/I ROAD KING	98>99	•
1450 FLHT/I ELECTRA GLIDE STANDARD	98>99	•
1450 FLTR/I ROAD GLIDE	98>99	•
1450 FX DWG DYNA WIDE GLIDE	99	•
1450 FXDS DYNA SUPER GLIDE SPORT	98>99	•
1450 FXRS SPORT GLIDE	84>86	•
1450 FXRT TOUR GLIDE	84>86	•
1450 FXSTB ICE BOB	00>03	•

A = 292 B = 50,5  
C = 82,5 D = 10,3  
E = 5

### 68B407E1 KYMCO

250 XCITING	05>	•
250 XCITING	05>	•
300 XCITING/R	08>	•
500 XCITING	04>	•
500 XCITING R	07>	•

A = 260 B = 105  
C = 130 D = 10,6  
E = 5

Code			
------	---	---	---

<b>68B407E2 MALAGUTI</b>			
500 SPYDER MAX GT	04>	•	
500 SPYDER MAX RS	09>	•	

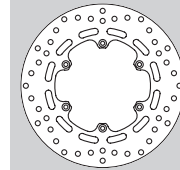

A = 260 B = 120  
C = 135 D = 6,5  
E = 4

### 68B407E4 YAMAHA

125 SR	95>	•
350 RD LC	85>93	• •
400 FZ R	85>87	•
500 T-MAX	01>03	•
500 T-MAX/BLACK MAX	04>07	•
500 T-MAX/ABS	08>	•
500 RD LC	84>88	•
600 SRX	86>	•
600 XJ F	83>90	• •
600 XT all models	83>85	•
600 XT - E	90>94	•
600 XT TENERE'	83>89	•
600 XTZ TENERE'	86>91	•
750 FZ GENESIS	89>92	•
750 FZ	85>88	• •
750 FZX	87>	• •
750 XJ F	83>88	•
750 XV VIRAGO	87>93	•
900 XJ F	83>90	•
900 XJ DIVERSION	94>	•
1000 FZR	87>88	•
1000 FZR GENESIS	87>88	•
1000 FZR EX-UP	89>90	•
1000 FZR EX-UP	91	•
1000 FZR EX-UP	92>93	•
1000 FZR EX-UP	94>95	•
1000 FZS FAZER	01>05	•
1100 BT BULLDOG	02>	•
1100 XV VIRAGO	87>93	• •
1200 XJR	95>98	•
1300 XJR	99>	•
1300 XJR SP	99>	•
1670 MT-01	05>	•



A = 267 B = 132  
C = 150 D = 8,5  
E = 5

### 68B407E5 MALAGUTI

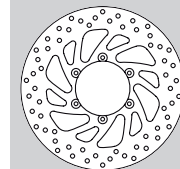
250 PASSWORD CK 250	05>	•
400 MADISON	02>	•
500 SPYDER MAX GT	04>	•
500 SPYDER MAX RS	09>	•



A = 270 B = 90  
C = 101,5 D = 6,25  
E = 4

<b>Code</b>			
-------------	---	---	---

### 68B407E6

#### YAMAHA

125 X-CITY	08>	•
250 X-CITY	07>	•

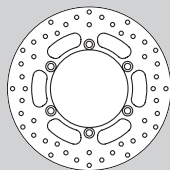

A=270 B=128  
C=146 D=8,5  
E=5

### 68B407E7

#### HONDA

400 SW - T 400	09>	•
----------------	-----	---

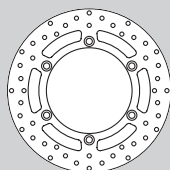

A=276 B=144  
C=166 D=10,5  
E=6

### 68B407E8

#### DUCATI

1098 1098/R/S/TRICOLORE	07>	•
1099 STREETFIGHTER/S	09>	•
1198 1098 R/BAYLISS	09>	•
1198 1198/R/S	09>	•

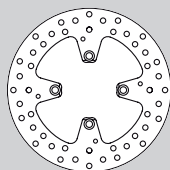

A=245 B=83  
C=102 D=10  
E=5

### 68B407E9

#### HONDA

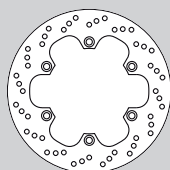

125 CBR R	03>07	•
400 VFR R	86>88	•
600 CBR F	87>90	•
600 CBR F	91>94	•
600 SILVER WING	07>	•
600 SILVER WING ABS	03>	•
600 XL V TRANSALP	87>90	•
600 XL V TRANSALP	91>93	•
600 XL V TRANSALP VR/VT	94>96	•
650 SLR	97>99	•
650 VIGOR FX	99>01	•
750 CBX F	84>88	•
750 VFR F	85>87	•
750 XLV R	83>87	•
1000 VF F	84>88	•
1000 VF R	86>87	•



A=276 B=144,5  
C=166 D=10,5  
E=5

#### TRIUMPH

900 TIGER	93>98	•
-----------	-------	---

<b>Code</b>			
-------------	---	---	---

### 68B407F0

#### KTM

690 DUKE	08>	•
690 SM	07>	•
690 SM R	08>	•
950 ADVENTURE/S	03>	•
950 SUPERENDURO R	06>08	•
990 ADVENTURE S/ABS	06>07	•

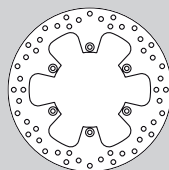

A=240 B=110  
C=125 D=6,5  
E=6

### 68B407F1

#### KTM

950 SUPERMOTO	05>07	•
990 SUPERDUKE	05>	•
990 SUPERMOTO	07>08	•

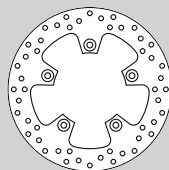

A=240 B=107,5  
C=130 D=8,5  
E=5

2