

INSTALLATION INSTRUCTIONS

Honda Gold Wing | 2018 →

EXHAUST SYSTEM:
Slip-on



SYMBOLS

The following symbols are used throughout these installation instructions:



TOOLS AND PROTECTIVE EQUIPMENT REQUIRED



TIGHTENING TORQUE



LUBRICATION



HAND TIGHTEN



INSTALLATION TIP



CAUTION OR IMPORTANT



MOVEMENT ARROW



INDICATOR ARROW



CERAMIC PASTE

For lubrication and corrosion protection on screws, bolts, fits and pins. Free of standard and heavy metals, prevents sticking and seizing, neutral to all known sealing materials, non toxic, up to +1400°C heat resistant, short term up to +1600°C, prevents wear and tear.



TOOLS AND EQUIPMENT

Use appropriate safety equipment like eye protection and mechanic gloves! Use appropriate and working tools for mounting and dismounting of the exhaust system.



We congratulate you on buying a product from REMUS and thank you for your trust. We are always striving to offer the very best product for your vehicle through continuous innovation processes and usage of the latest technologies.

READ THIS

Please read this entire installation manual carefully prior to installing and using the REMUS exhaust system.

REMUS exhaust system should only be installed by persons skilled in car/motorcycle exhaust system installation and performance. The instructions provided in this manual should be followed to ensure proper installation and safe use of the REMUS exhaust system. REMUS and/or its partners shall not be held liable for any damage or personal injury (including direct, indirect, or consequential damage) sustained as a result of improper installation of the REMUS exhaust system or its use and maintenance contrary to the instructions and warnings contained herein.

If you have any questions regarding the installation and/or proper use of the REMUS exhaust system or this manual, please contact your local REMUS partner.

For more information on the REMUS exhaust systems, see the official REMUS website at: <http://www.remus.eu>

GENERAL INFORMATION

Your safety is our number one priority. Please drive your car/motorcycle responsibly, safely and always obey local traffic rules.

All statements made with regard to the exhaust system's compliance are made in respect of the exhaust system "as is". Any modifications of the REMUS exhaust system or its improper installation, use or maintenance that is not in accordance with this Installation manual, may result in severe damage to the exhaust system and/or engine, as well as personal injury, and may affect the exhaust system's compliance with the legal requirements, such as exhaust system's air and/or noise emissions (as an example, the car/motorcycle may not be suitable for use on public roads any longer), as well as warranty coverage.

If the REMUS exhaust system is manipulated in any way, the type approval is no longer valid!

The exhaust system may only be used in accordance with relevant laws and regulations, including state and federal, where applicable.

Damage caused by improper installation, use and maintenance of the REMUS exhaust system is not covered by the REMUS warranty.

Technical specifications of REMUS exhaust systems and related products are subject to change without notice.



RIGHTS & NOTES

COPYRIGHT, OTHER RIGHTS NOTICE AND GENERAL NOTES

The REMUS trademark, including corporate logos and emblems, are subject to copyright as well as trademark rights of REMUS, its licensors, or third persons authorizing REMUS to use them. Any reproduction, technical or other manipulation, translation, or other use of the copyright and/or trademark rights contained herein is prohibited without the explicit prior written consent of REMUS.

The same especially applies to the entire contents of this manual and/or any of its parts, including but not limited to technical specifications, instructions, graphs, photographs, and so on included in this manual.

The photographs and other illustrations in this manual are symbolic and are intended to help represent individual steps for proper installation and use, as well as for a general overview.

The actual component parts of the REMUS exhaust system may not entirely correspond to the photographs and other illustrations.

REMUS takes all copyright and other rights infringement cases under serious consideration. If you have any reason to believe that your exhaust system is not an original REMUS product, please contact our local partners or REMUS at office@remus.at



SAFETY WARNINGS

IMPORTANT SAFETY WARNINGS, PLEASE READ CAREFULLY

The car/motorcycle should be in the off position throughout the whole dismantling and mounting process, as well as any other work done on the exhaust system!

Before dismantling the exhaust system, lock the car/motorcycle and remove the key from the vehicle to avoid electrical errors in the control units!

For proper dismantling and mounting of the exhaust system, it is recommended to use a certificated and tested lifting device.

The exhaust system can get extremely hot during and after it is used. Allow the exhaust and engine to cool down before touching it and beginning installation.

Make sure that you have all the parts necessary for the installation of your new REMUS exhaust system, according to the parts list in this manual. If any of the parts are missing, please do not proceed with uninstalling your stock exhaust system/installing the REMUS exhaust system and contact the retailer you bought the REMUS exhaust system from.

CAUTION: make sure not to injure yourself or damage any part of the vehicle during dismantling and mounting of the exhaust systems!

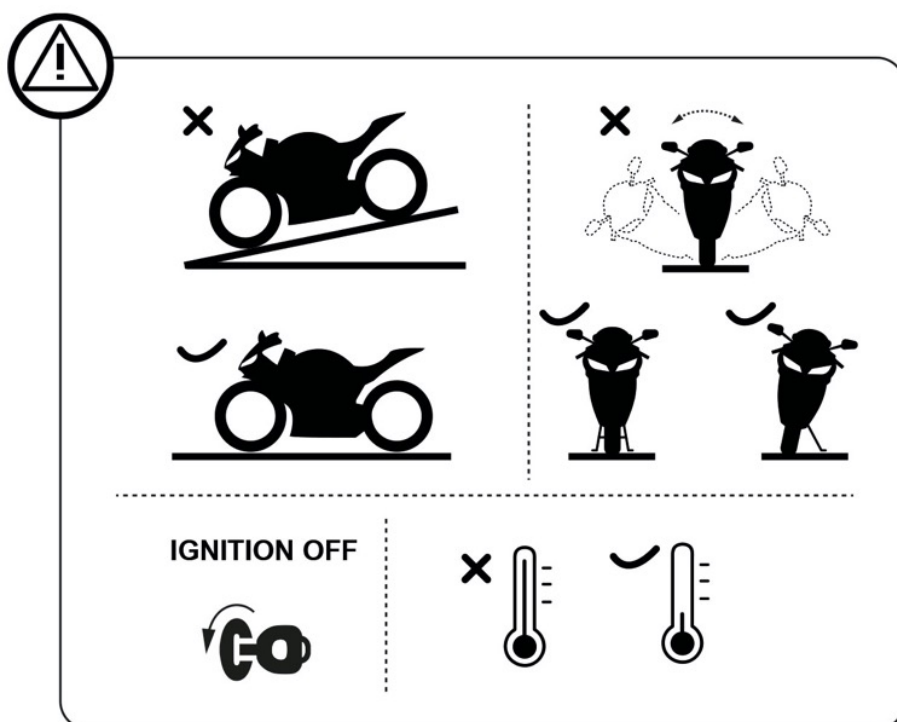

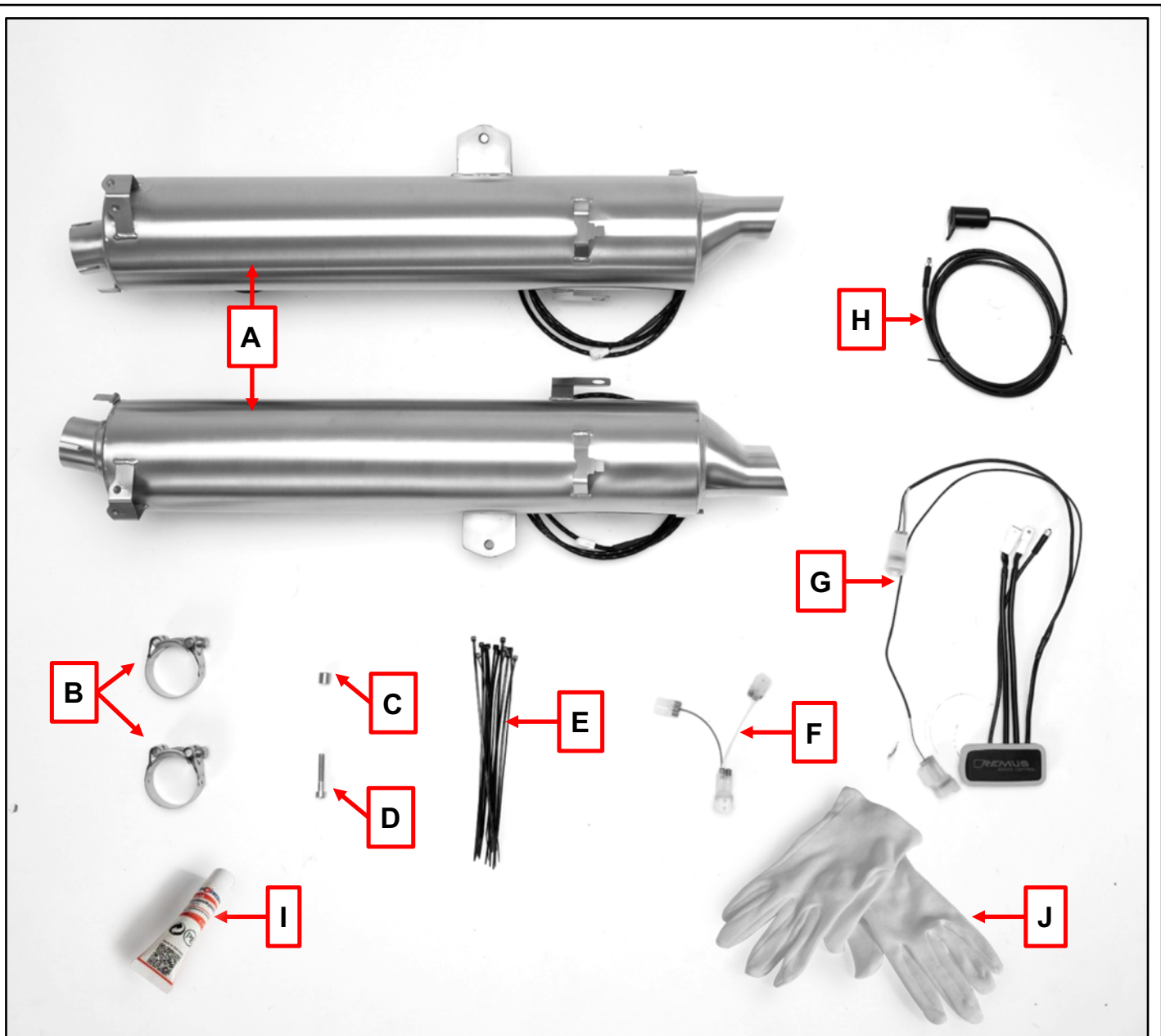

pos	pcs	packing content
A	2	sport exhaust
B	2	clamp
C	1	spacer
D	1	screw M6x35mm
E	12	cable ties
F	1	adapter cable
G	1	REMUS control unit
H	1	flap control button
I	1	copper paste
J	1	pair of gloves

REMOVAL

OF STOCK EXHAUST SYSTEM:

The process of uninstalling the original exhaust system may vary depending on the existing exhaust system. Please follow the original exhaust system manufacturer's instructions for uninstalling the original exhaust system.

If you for any reason decide otherwise, please note that any information provided in this respect herein should be considered as general information provided for your convenience only.

REMUS shall not assume any liability or responsibility with regard to uninstalling your existing exhaust system, warranty coverage of such exhaust system or vehicle or their further fitness for use.



REMOVAL OF STOCK EXHAUST SYSTEM:

Remove the plastic covers and the front heatshields on both sides.

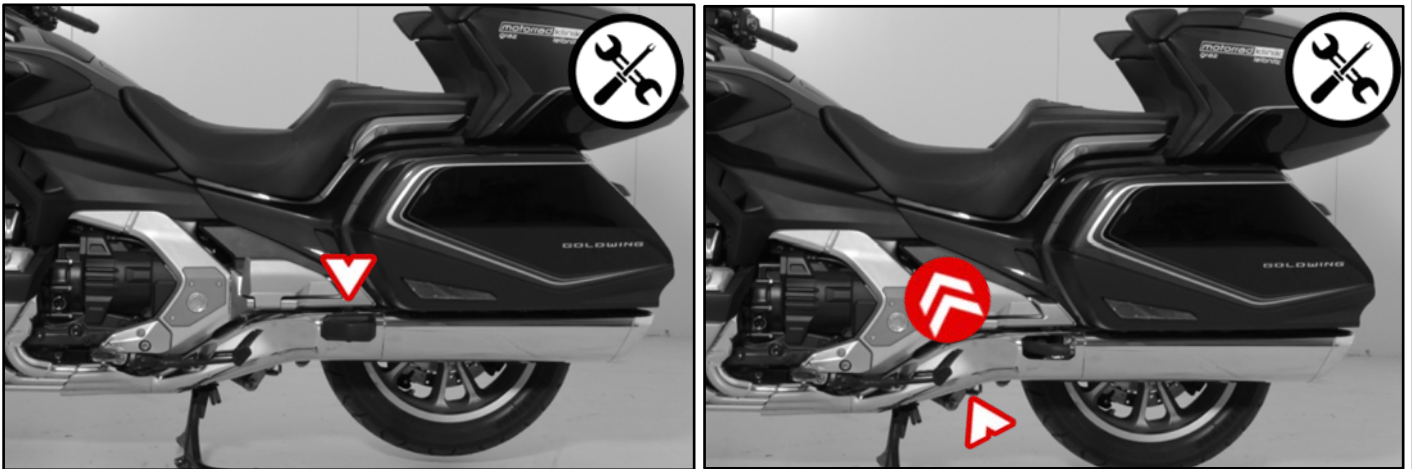

Remove the side covers and dismount the seat.

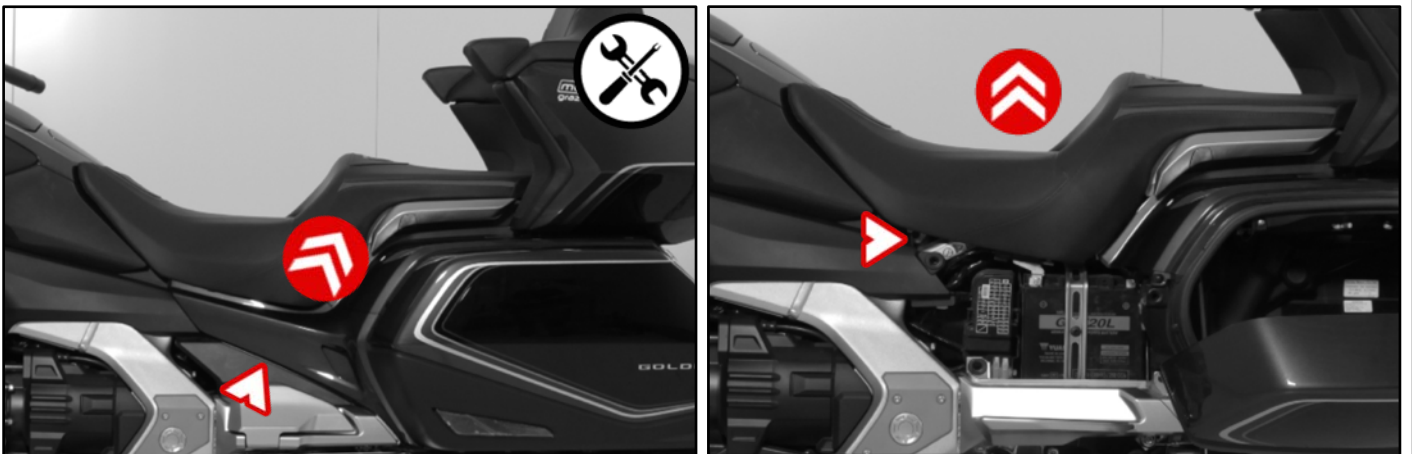

Loosen the screws of the clamps as well as the screws of the brackets and remove the mufflers.

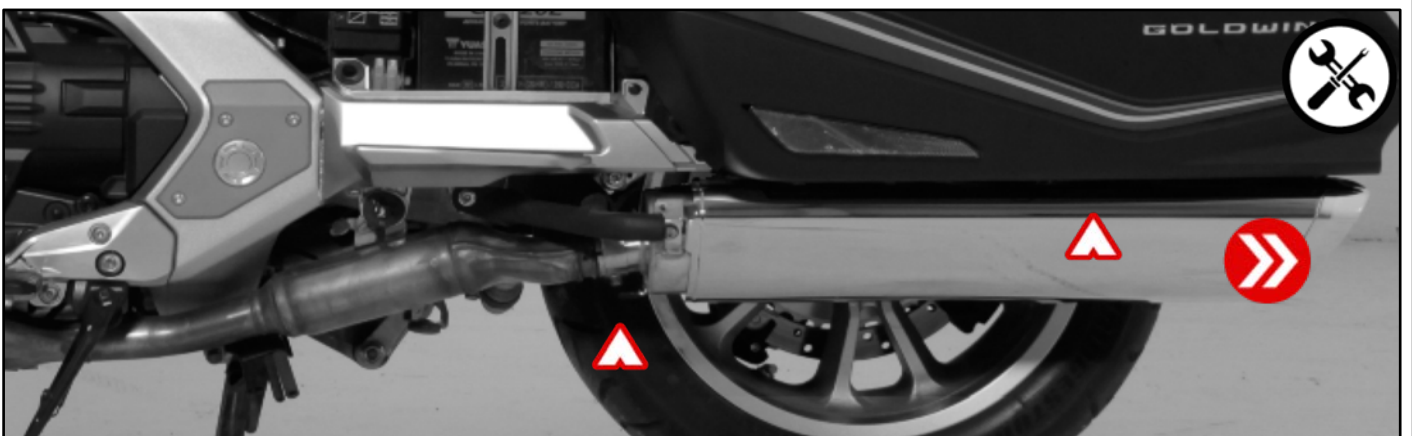

INSTALLATION OF THE REMUS EXHAUST SYSTEM

Dismount both heatshields from the stock mufflers. Dismount the rubber guides of the stock mufflers / heatshields.

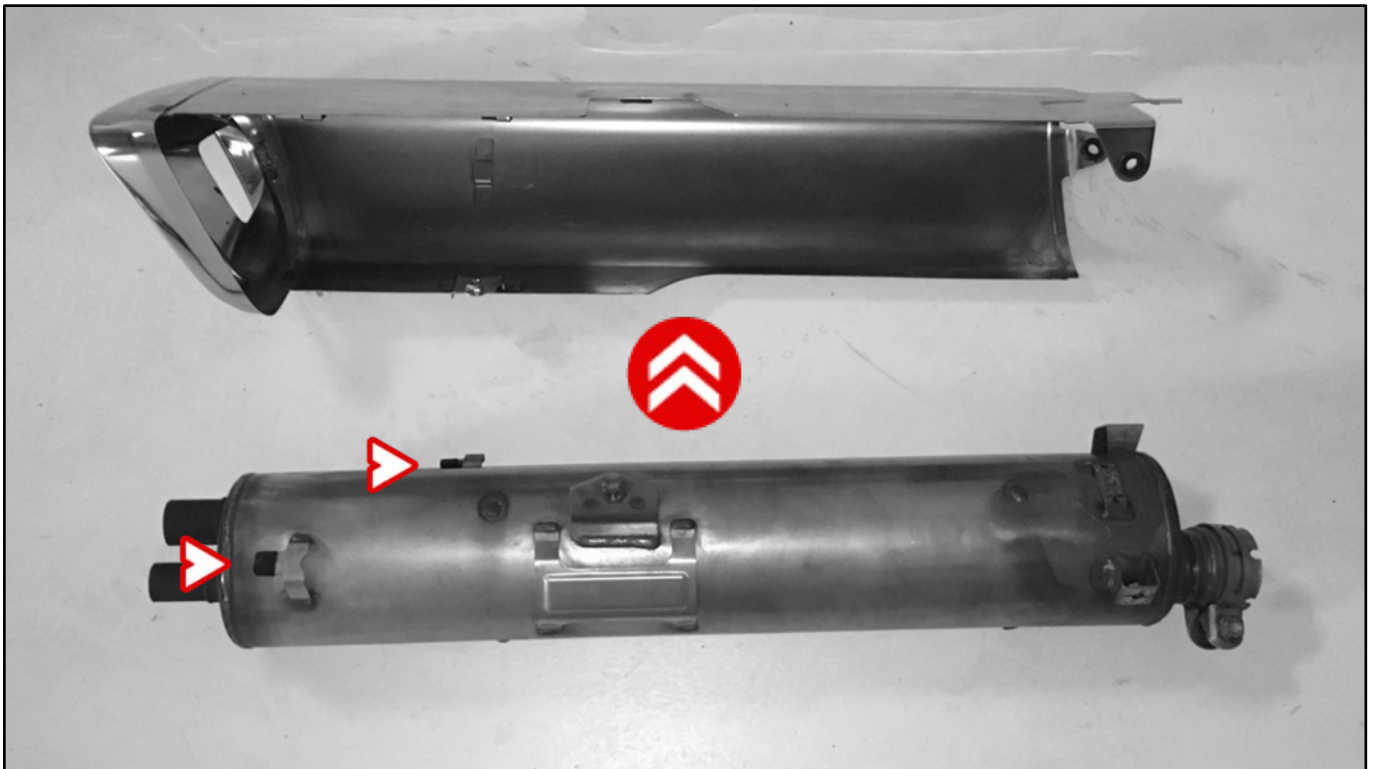

Mount the rubber guides onto the REMUS sport exhausts.

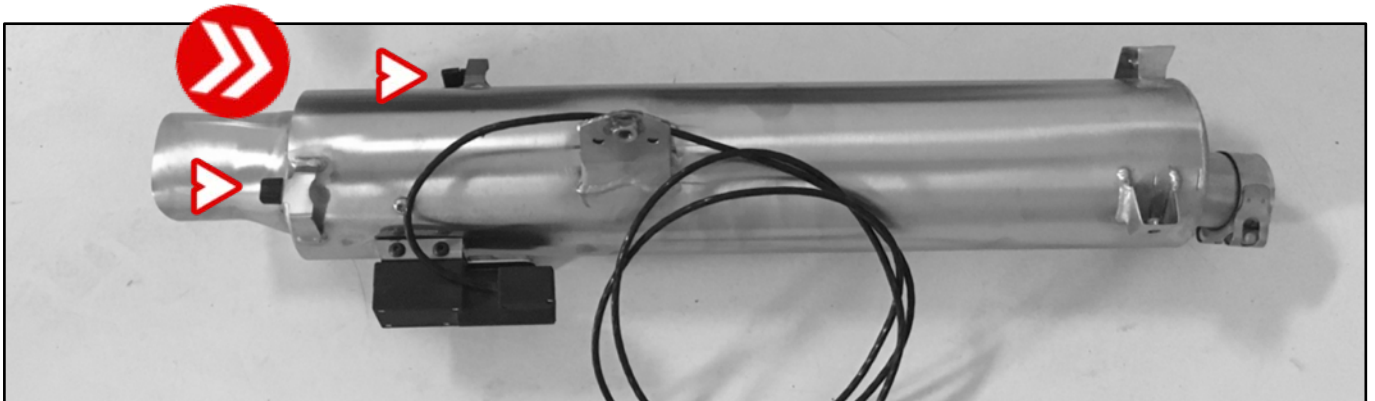

Mount the main heat shields onto the REMUS sport exhausts.



The small heat shields aren't necessary with the REMUS exhaust system and can be left out.

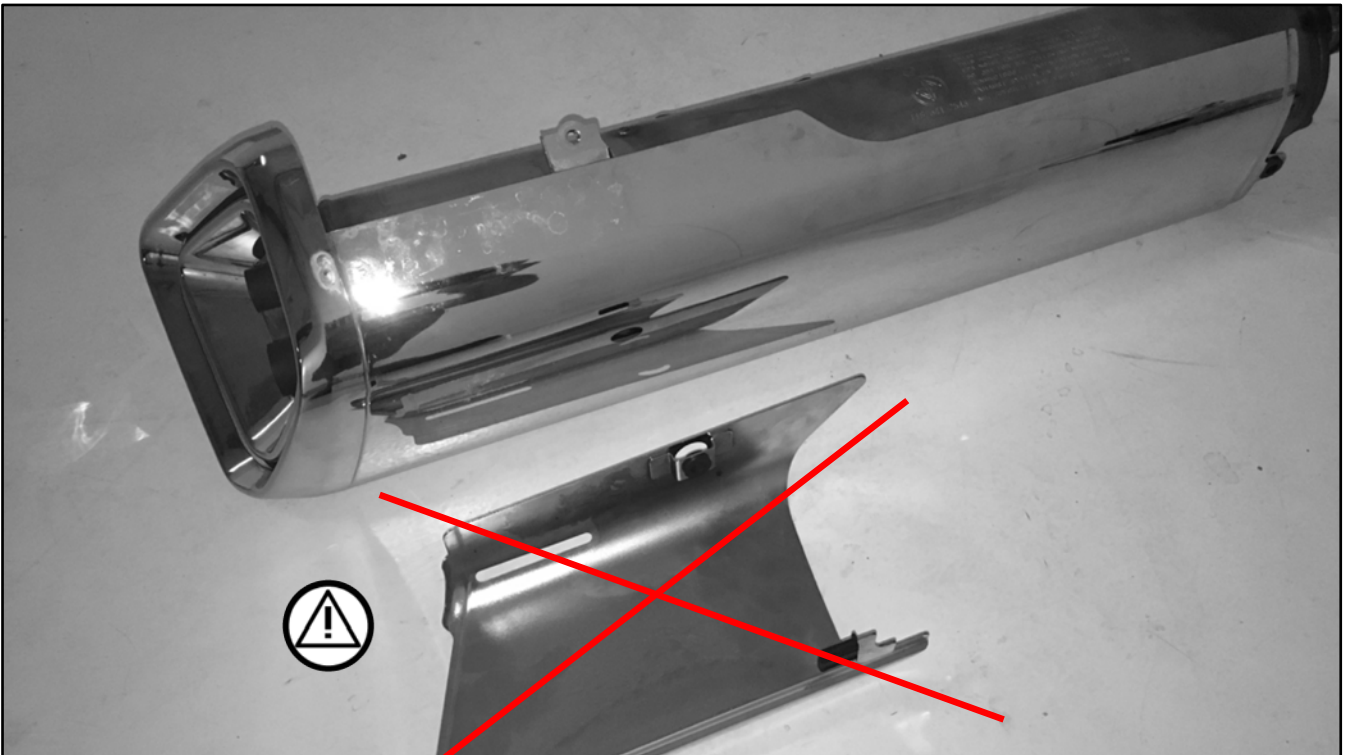

Install the REMUS sport exhausts onto the serial headers, use the supplied clamps.

 **Tighten the clamps only hand-tight!**

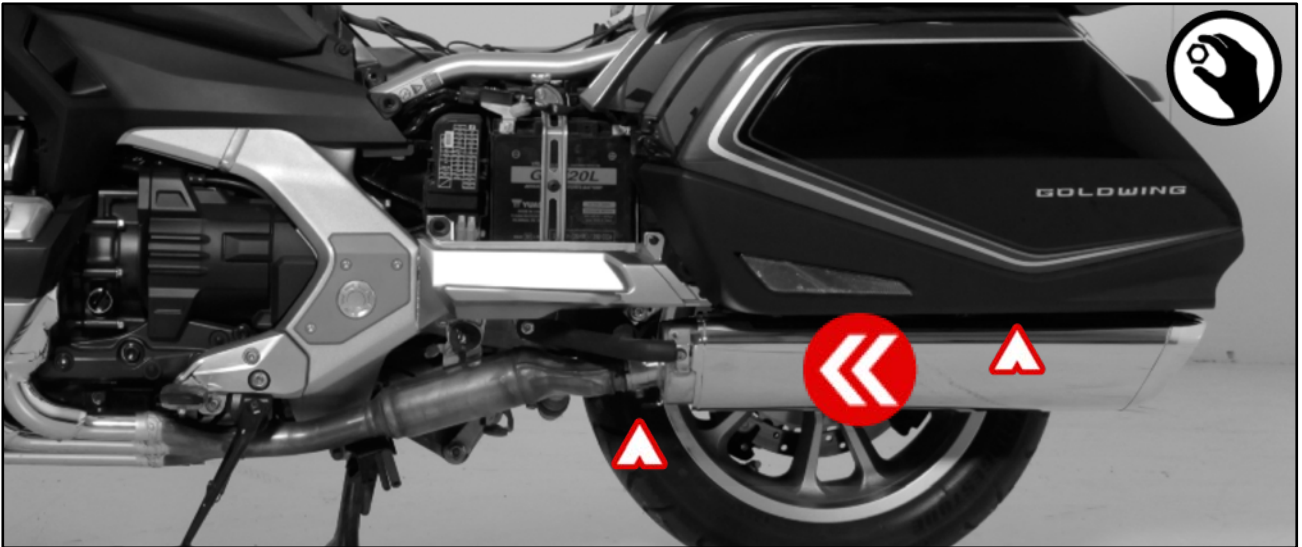

Guide the actuator cables of the actuators as shown in the picture.

 **Make sure that the cable does not come into contact with hot or moving parts!**



Remove the cover and mount the supplied flap control button onto the handle bar.

 **Use the supplied screw and spacer!**



Guide the control cable along the motorcycle, as shown on the picture.

 **Make sure that the cable does not come into contact with hot or moving parts!**

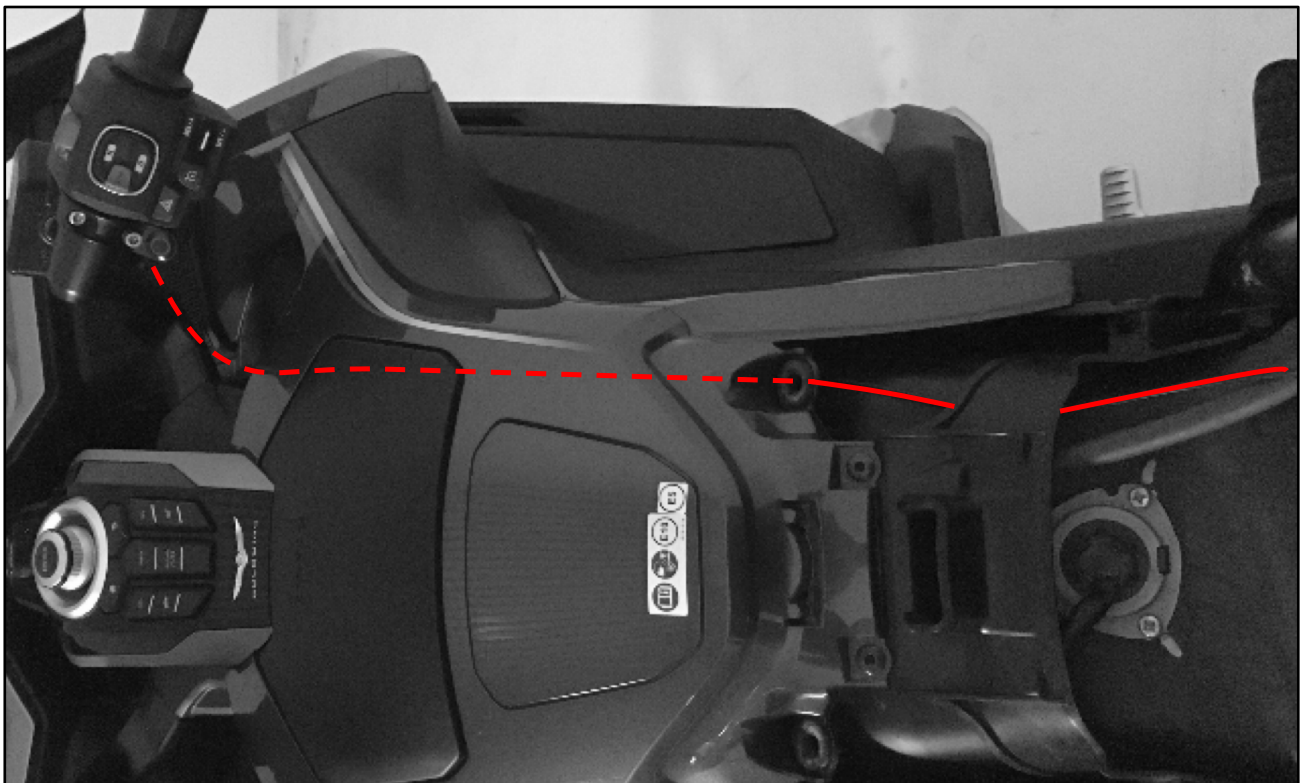



Only for EURO 4 Models 2018-2020:

Connect the cables of the actuators and flap control button to the REMUS control unit.

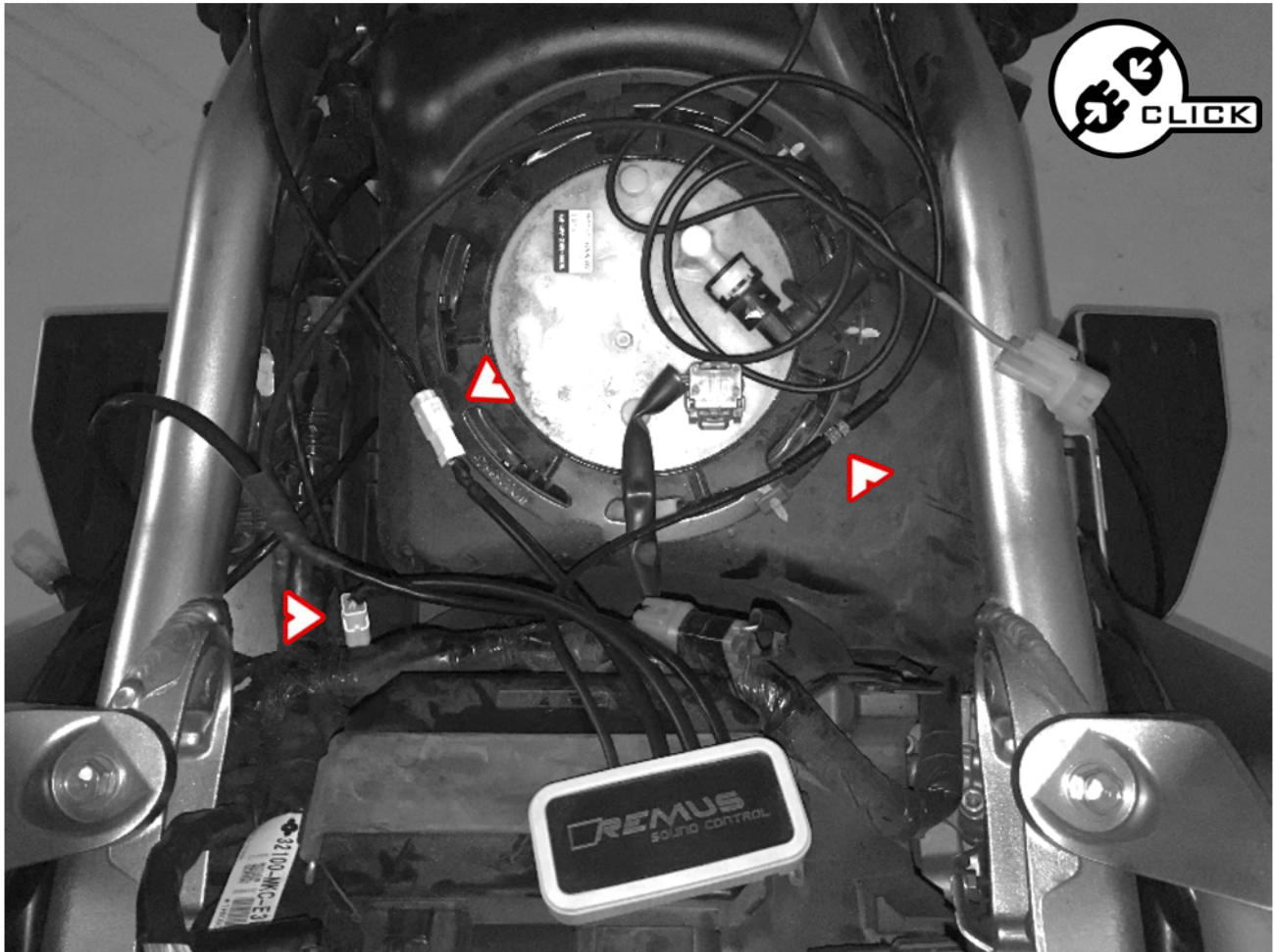

Guide the single-pole plug to the right and the three-pole plug to the left side of the vehicle, to the respective plug connections. You will find these behind the previously removed side panels.

RIGHT SIDE

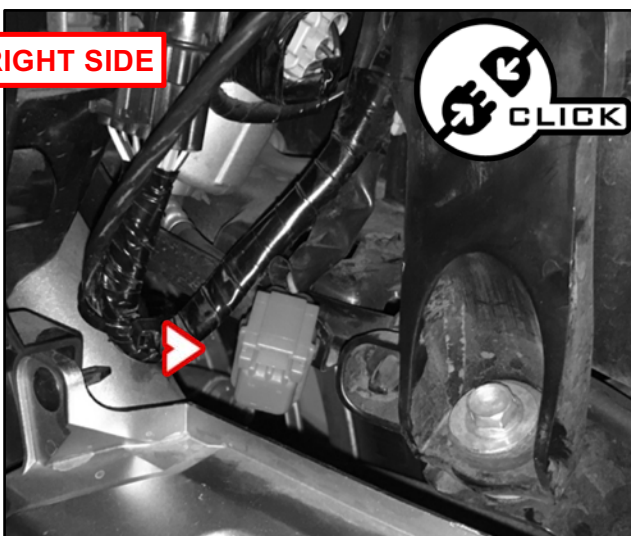

LEFT SIDE



Continue on page 15.





Only for EURO 5 Models up from 2021:

Connect the supplied adapter cable in between the serial connector and REMUS control unit.

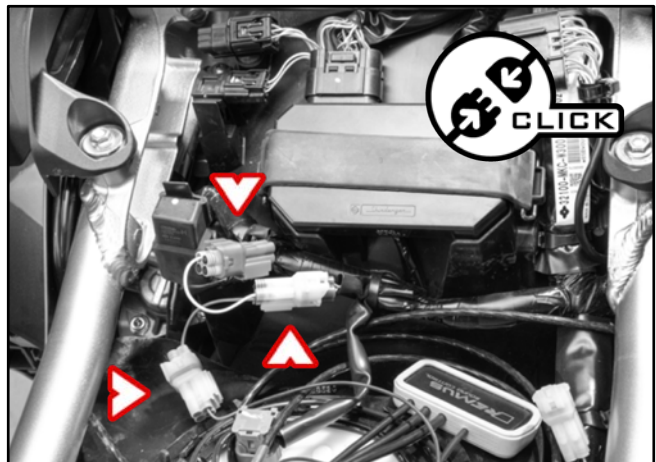
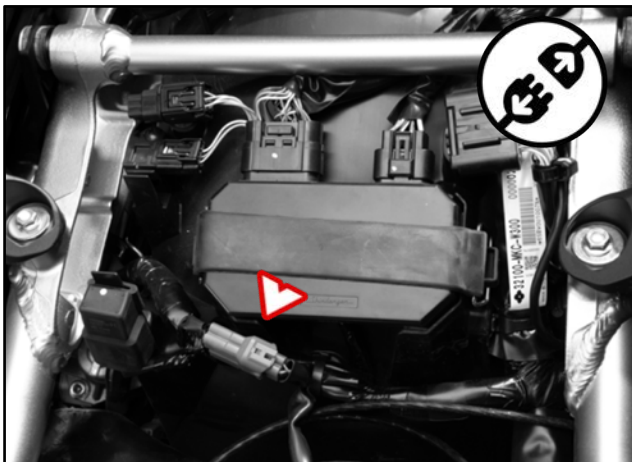

Connect the cables of the actuators and flap control button to the REMUS control unit.

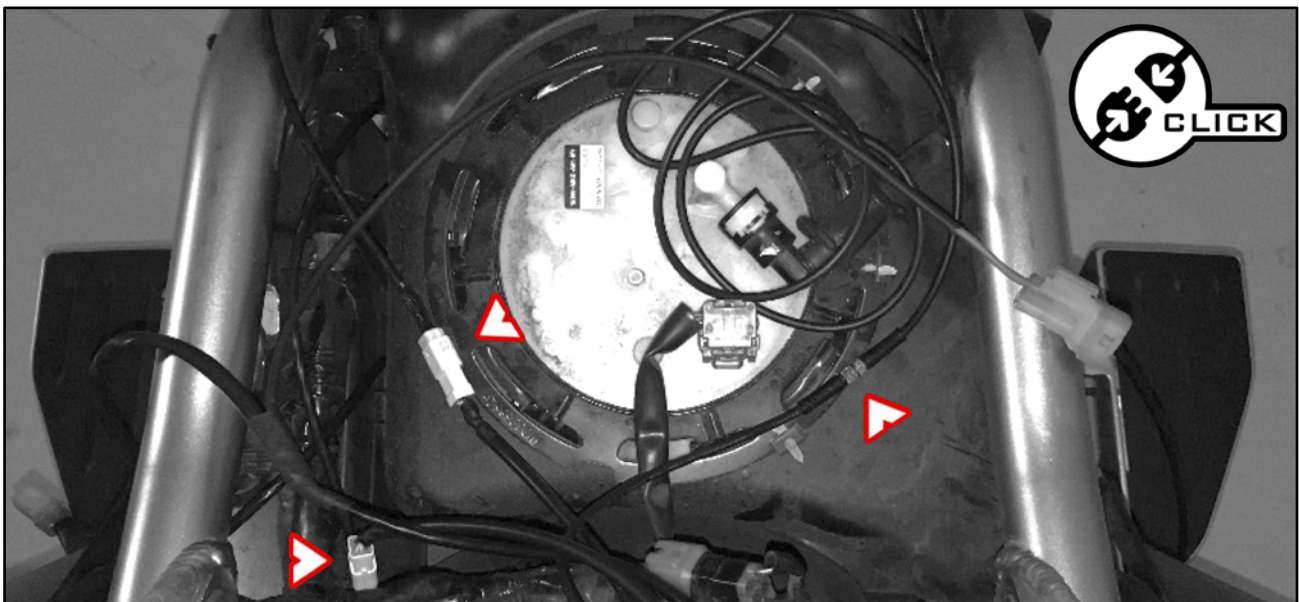

Guide the three-pole plug to the left side of the vehicle, to the respective plug connection. You will find these behind the previously removed side panels.



Align the REMUS sport exhaust and tighten the connections.

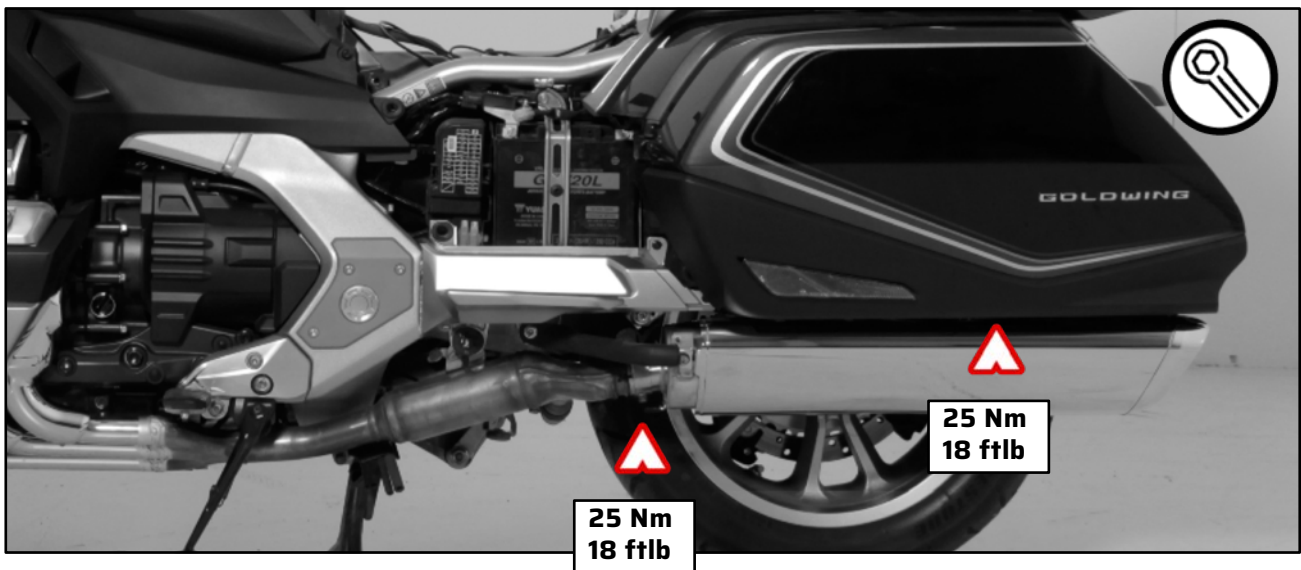

Remount all previously removed parts and fix all cables by using cable ties.



FINAL STEPS

IMPORTANT: reinstall the dismantled or partially removed stock parts (wheel arches, bumper etc.); check vehicle manufacturer manual for tightening torques.

IMPORTANT: make sure all the nuts and bolts are sufficiently tightened. In case the exhaust system touches the cowling or other parts, repeat the adjustment of the exhaust system or contact your authorized dealer.

IMPORTANT: clean all exhaust components before the first start of the engine or the stains will burn onto the surfaces!

TROUBLESHOOTING

Problem	Possible cause	Solution
Exhaust gas is leaking out of the exhaust system	loosened clamp	tighten all connections to specified torque
	connection is not completely joined	loosen the connection and tap it into place, tighten the connection to specified torque
Valve is not working / moving	Valve is mechanical stuck	Remove the actuator and try to move the valve by hand. Use spray lubricant (WD-40® or equivalent) to make the valve working again.
	Valve is not working correct	Make sure the actuator is powered correctly. Make sure the actuator is mounted properly onto the valve and the valve spins correctly.
Exhaust system rattles / doesn't fit properly	Exhaust System is not mounted correct	loosen all connections again and readjust/align the whole system once more



MAINTENANCE

STAINLESS STEEL PARTS:

Clean stainless steel components with soft cloth sprayed with contact cleaner, then wipe with soft and dry cloth.

CARBON PARTS:

Clean carbon fiber exhaust components with soft and dry cloth.

TITANIUM PARTS:

Clean the titanium exhaust components with a multi-purpose spray lubricant (WD-40® or equivalent).

A change in the color of the exhaust system is normal due to high temperatures. Periodically make sure all the bolts and springs are sufficiently tight.



IT IS NORMAL FOR WHITE SMOKE TO COME OUT OF THE MUFFLER AT FIRST OPERATION.



CAUTION: DO NOT STAND BEHIND THE MUFFLER AT ANY TIME.



CAUTION: DO NOT USE AUTOMOTIVE WHEEL CLEANERS OR ANY CLEANING PRODUCTS WHICH CONTAIN ACIDIC ADDITIVES TO CLEAN THE REMUS EXHAUST SYSTEMS.



THE SOUND OF REMUS®

FIRST CLASS QUALITY DESIGNED & BUILT IN EUROPE | AUSTRIA

www.remus.eu



REMUS Innovation GmbH
Ruhmannstraße 11
A-8570 Voitsberg